

PORTABLE POWER STATION

T500 User Manual

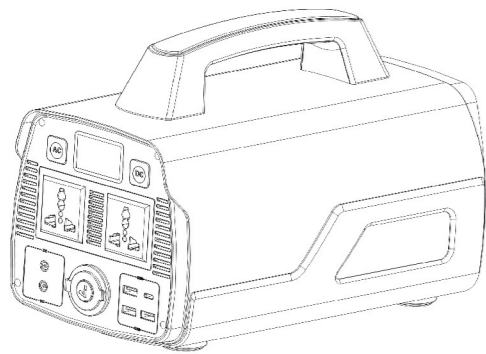

Thank you for purchasing this multifunctional lithium power generator.

This unit will provide portable power with a range of AC / DC / USB outputs, to keep your smart phones, tablets, lights, fans & TV or other electrical devices charged & operating.

Before using this unit, please read the user manual carefully and retain it for future reference.

ATTENTION:

- This product provides a range of AC voltage outputs: 100V-240V/50Hz-60Hz. Keep out of reach of children when in use, and store safely, to avoid the risk of electric shock.
- This is universal user manual, AC output sockets, AC output voltage, AC output frequency and AC charger plug will be different according to different countries and areas. Please refer to the actual product.
- Please read this user manual carefully before using the unit, and check carefully that the unit's voltage output matches your electric appliance's voltage. This is important to ensure that you do not damage your electrical appliance.

Notice: Lock Mode

Some smart devices like Bluetooth headphones and smart watches, require very small input current to charge, which could be less than current detection limitation of the unit. Any such smart devices will not be able to be charged by the standard USB charging function of this unit.

To be able to recharge such devices, long press the "DC button" for 3 seconds. This will turn the "DC Lock On" to keep the USB port output running. Please press the "DC button" to turn off "DC Lock On" when the USB device is fully charged to save power.

When the "DC Lock On" mode is on, the "DC Output" and "USB Output" icons on the LCD display panel will keep blinking. When "DC Lock On" is turned off, the two icons will stop blinking and become solid. DC outputs and USB outputs will turn off.

【VI】AC OUTPUT

This unit has 2x AC Output(100V-240V/50-60Hz, rated power:500W, peak power:1000W.)The detailed specifications will be customized according to different countries and areas. Please refer to the base of the unit for your specifications.

To use, connect the power cable plug of the electric appliance to the AC outlet. Switch on the "AC button", the AC indicator on the LCD display panel will light up, and the unit will start providing power to your appliances.

☆NOTE: When the AC switch is turned on, the real-time power will be shown on the display panel.

☆NOTE: When there is no AC output (AC power less than 20W), the AC output will automatically switch off after 4hours, and the unit will enter a low power state.

AC Output Frequency 50Hz/60Hz Changing Function:

When the AC output is on (AC indicators on LCD display is on):

- Press the DC button and hold on
- After 2 seconds, it will enter into the DC lock mode (DC and USB indicators on LCD display is flashing on)
- Keeping pressing the DC button, and short press and AC button 3 times, it will display the changed frequency
- Release the DC button, then the changed frequency is confirmed, and then can use the unit normally

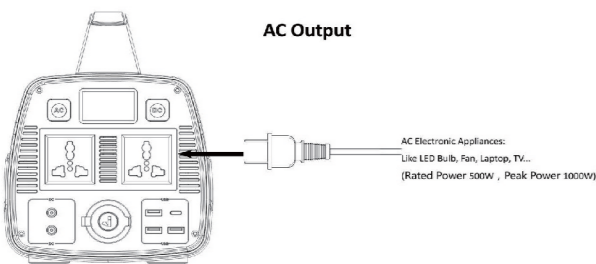

Protection Modes:

- Low-Voltage Protection: to protect the battery from over-discharge. When the battery is running out of power, the AC output will automatically turn off. Please ensure that the unit is sufficiently charged.
- Over-Voltage Protection: to protect the electric appliance from burnout. When the battery voltage is detected as too high, the AC output will automatically turn off. Please return it to factory for processing.

【 I 】 INTRODUCTION

【Product Parameters】

Battery	Lithium Ion Batteries
Battery Capacity	518WH/14000mAh/ . V
Dimensions(Length*Width*Height)	310*170*213MM
Weight	About 6.6 KG
Input Recharging	AC Charger: DC V A Car Charger: V A Solar Panel: MPPT, V V AMAX
Fully Charged Time	Adapter: DC V A . hms
DC Output	2 x DC5521 : 12 ~ 16.8V/10A (14.5A Max)
USB Output	2 x USB-A: 5V/2.4A 1 x USB-A: QC3.0 , 5 ~ 12V/18W 1 x TYPE-C: PD3.0 , 5 ~ 12V/18W
AC Output	Pure Sine Wave Output: Rated Power: 500W(Peak Power: 1000W) AC Voltage: 100V/110V/120V/220V/230V/240V Output Frequency: 50/60Hz ☆For actual voltage and frequency please refer to the sticker at the bottom of the unit.
Cigarette Lighter Output	1 x Cigarette Lighter Output: 12 ~ 16.8V/10A (14.5A Max)
Power Indicator	LCD Display
Discharging Temperature	-10°C ~ +40°C
Charging Temperature	0°C ~ +40°C
Life-cycles	>500 times
Package Contents	1x Portable Power Station 1x AC Charger 1x Car Charger 1x User Manual

【Product Description】

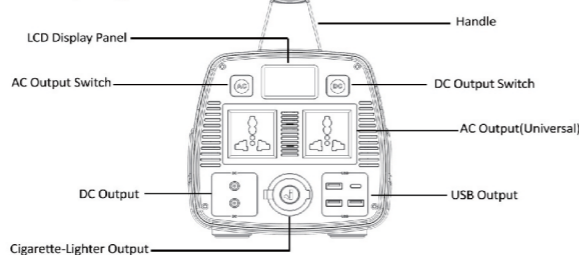

Notice: Lock Mode

Some smart devices like Bluetooth headphones and smart watches, require very small input current to charge, which could be less than current detection limitation of the unit. Any such smart devices will not be able to be charged by the standard USB charging function of this unit.

To be able to recharge such devices, long press the "DC button" for 3 seconds. This will turn the "DC Lock On" to keep the USB port output running. Please press the "DC button" to turn off "DC Lock On" when the USB device is fully charged to save power.

When the "DC Lock On" mode is on, the "DC Output" and "USB Output" icons on the LCD display panel will keep blinking. When "DC Lock On" is turned off, the two icons will stop blinking and become solid. DC outputs and USB outputs will turn off.

When the "DC Lock On" mode is on, the "DC Output" and "USB Output" icons on the LCD display panel will keep blinking. When "DC Lock On" is turned off, the two icons will stop blinking and become solid. DC outputs and USB outputs will turn off.

Notice:

- This unit has a "3 second" delay from pressing the AC button to AC voltage output. This is a soft start delay design. This is normal.
- In the event of over-current protection or short-circuit protection occurring, this unit will try to restart three times in order to eliminate the protection malfunction caused by a high starting current but low working current of electric appliances. After restarting, AC output will be turned off and will show on LCD Display panel that AC is wrong.
- Please turn off the AC output after using it.
- If the ambient temperature is high and the power consumption is large, even if the inbuilt fan is on, the product heat may accumulate to reach the overheat protection value. At this time, please turn off the AC output to protect the inside components from over temperature damage. And use this unit again after the temperature drops, or reduce the load power.
- In the event of the battery capacity is about to run out, the low-voltage protection of AC output will be turned on before that of DC output, so as to make better use of the remaining power. The DC output can be turned on normally while AC output can not, which is normal.
- The power displayed is only approximate. The actual power is related to the characteristics, efficiency, power and other factors of the electrical appliance.
- When AC is running at no load, a basic power value will be shown at the display panel due to the inverter itself heats up, which is normal.

Warning:

- Before using the AC output, you must confirm that the AC output voltage and frequency of this unit is matched with those of the electric appliance, so as not to damage the appliance.
- The power of AC electric appliances you use must be less than the allowable maximum power (500W) of this unit.
- When the AC port is not in use, turn it off to conserve power.

【VII】RECHARGING

Connect the charger plug to the DC Input of the unit to charge it. The power indicators will blink and the fan continues to run at a low speed to indicate that the unit is charging. When the unit is fully charged, all power indicators will stop blinking and remain solid. After the unit is fully charged, remove the charger plug.

The unit has a variety of charging protection functions, supports multiple charging methods, and supports charging and discharging at the same time, which is very suitable for solar charging.

Protection Modes:

- Charge Over-Current Protection: this unit has maximum charge current limitation, so as to prevent excessive charge current from damaging the battery and circuit components.
- Charge Over-Voltage Protection: this unit has maximum charge voltage limitation, so as to prevent excessive charge voltage from damaging the battery or causing a fire.
- Trickling Charge: if the battery is seriously depleted, it will use small current to charge the unit. This unit supports 3 ways of recharging (as below). You can use this unit when it's charging.

1. Charge through AC Charger

Using the included AC Charger (V A)plug the unit into any wall outlet to quickly charge the unit. The fully charged time is about . hours.

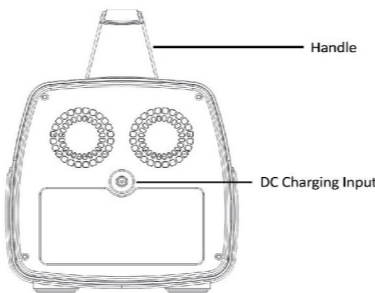

☆ NOTE:AC outlets, AC output voltage and frequency will vary according to different countries or areas. Please refer to the actual product before use. AC details are shown on the base of the unit.

【LCD Display】

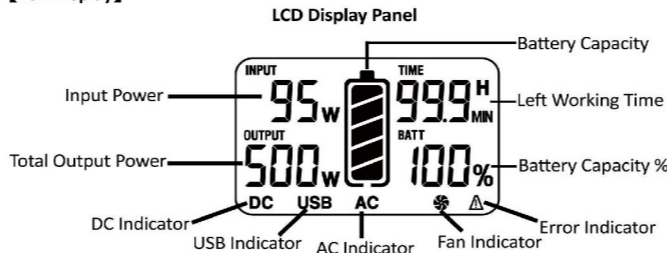

【 II 】 CHILD-PROOF LOCK MODE

1. Unlock Child-Proof Lock Mode: In order to prevent accidental pressing by children, the unit has Child-Proof Lock Mode. Please press the AC button and DC button for 3 seconds at the same time, then the "OPE" will be shown at the display panel to unlock. All functions can be used normally.

2. Child-Proof Lock Mode: Please press the AC button and the DC button for 3 seconds at the same time, the display panel shows "LOC", then the unit enters Lock Mode, and all the buttons will be locked.

ATTENTION:

- To prevent children from pressing the unit by mistake, it is recommended to keep the unit in Lock Mode when it is not in use.
- If the unit is not used for a long time, it is recommended to save it in Lock Mode to prevent collision and pressing buttons by mistake.

【III】LCD Display

- The power generator has LCD display, and has backlight mode
- When the backlight is on, all the buttons operations are function operation (the below operation instructions are default that the backlight mode is on)

Please remove the AC Charger after the unit is fully charged, so as to ensure the product safety and extend the life of AC Charger.

Charging: AC Charger

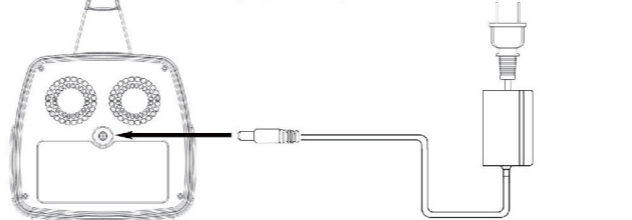

2.Charge from your car with a 12V Cigarette Lighter Adapter

Using the included car charger, plug the unit into a 12V cigarette lighter (car port) of your car. To protect your car battery and avoid car battery power loss, please charge this unit when your car engine is started.

Please remove the power cable after the unit is fully charged.

Charging: Car Charger

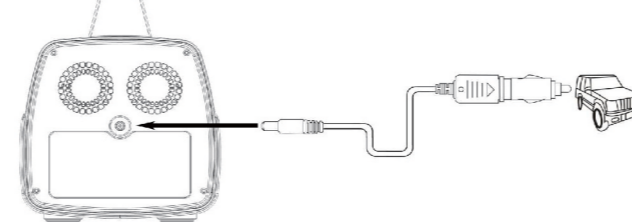

3. Charge from a Solar Panel

This unit is optimized for improving solar charging efficiency, with MPPT (Maximum Power Point Tracking) function. This supports a V V charging voltage and a maximum charging current of A, to ensure the maximum charging effect in limited sunshine.

Charging: Solar Panel

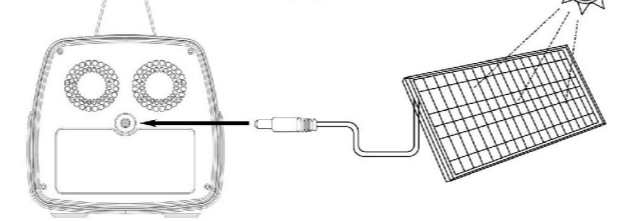

- When the backlight is off, the first buttons operation is to light up the backlight mode, and the second buttons operation is function operation. User could find the DC or AC function is open or not from the function indicators "DC" "USB" "AC" on LCD display

【IV】DC OUTPUT

This unit has 2x DC5521 outputs (voltage range: DC12V-16.8V and rated current is 10A (14.5A Max)). To use, connect the power cable plug of the DC electric appliance to the DC outlet of the unit (as below). Switch on the "DC button". The DC indicator on the LCD display panel will light up, and the unit will start providing power to your DC appliance.

In addition, you can charge car accessories by connecting the Cigarette Lighter Adapter to the DC Outlet of the unit (as below). Switch on the "DC button", the DC indicator will light up, and start charging DC car accessories. When turn on DC function, the output power value will be shown on the LCD display panel.

☆NOTE: When all DC and USB appliances are removed, the DC output will automatically switch off after 30 seconds, and the unit will enter a low power state.

1. How to charge DC12V appliances with this unit?

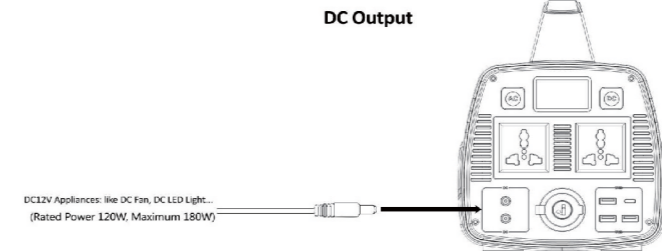

2. How to charge car accessories via Cigarette Lighter Socket?

This unit has a 12V-16.8V cigarette lighter with a rated output of 10A and a maximum of 14.5A, which can drive car equipment, such as car vacuum cleaners, car refrigerators, and car power tools.

Press DC button, when the DC indicator is on, it can supply power to car electrical appliances.

Notice:

- The plug of the cigarette lighter needs to be well protected from foreign objects, so as not to affect normal use.
- Cigarette lighter damage needs to be handled by professional maintenance, users do not disassemble.

DC Output: Cigarette-Lighter

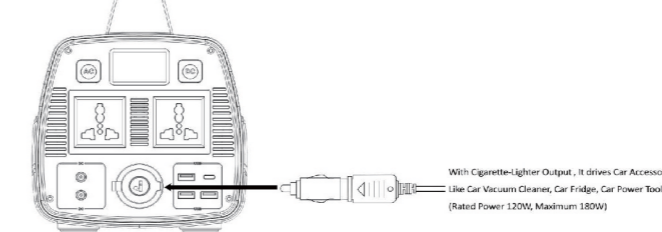

Notice:

- The actual charging effect of solar energy is related to local effective sunshine, climate, environment and other factors. Please equip solar panels according to local conditions.
- Place the solar panel in the strongest position in direct sunlight and avoid the shadows shielding the solar panel.
- If don't use the unit for an extended time, please disconnect the solar panel from the unit.

【VIII】PRODUCT NOTES

- This unit has built-in lithium batteries with no memory effect. Therefore there is no need to activate the batteries by charging and discharging.
- In order to extend the life of the unit (lithium battery), please charge it regularly and avoid deep discharge.
- In a low-temperature environment, the battery activity is reduced, and discharge capacity is reduced exponentially, please use the unit in an appropriate environment. Charging and discharging can increase the temperature of the unit to keep battery capacity at its highest.
- Use this unit in the range of +5°C ~ +30°C, to obtain the optimal charging capacity.
- Solar panel is compatible with V V voltage, and to achieve ideal charging efficiency, we recommend you to use Vsolarpanels.
- The life-cycle of battery charging and discharging is >500 times. After 500 times, the capacity will be significantly reduced, and will wear out eventually.

【IX】Display Error Instructions and Solutions

Error Indication Description:

- E1/E2 : DC Output Over-Current
- E3 : DC Output Short-Circuit
- E5 : AC Inverter Board Disconnected
- E6 : AC Output Over-load Protection
- E7 : AC Output Short-Circuit Protection
- E8/ E9 : AC Inverter Board Over-Temperature
- E10 : AC Inverter Board Input Voltage Too Low
- E11 : AC Inverter Board Input Voltage Too High
- E12 : AC Output Voltage Too High
- E13 : AC Inverter Board Error

Corresponding Solutions When Errors Occur:

- E1/E2: The total current of the using appliances exceeds the allowed maximum current, please remove some of the appliances to restart.
- E3: DC output is short circuit, please restart the output after troubleshooting.
- E5: When this error message appears, please contact the factory for processing.
- E6: The power of the current appliances exceeds the maximum available power of this unit, please use the appliances within the allowed power range.
- E7: AC output is short-circuited, please restart AC output after troubleshooting.
- E8/E9: Please wait for the temperature to drop or reduce the use of load power.
- E10: Please charge the unit to avoid over-discharging of the battery.
- E11: Detected battery voltage is too high, please contact the factory for processing.
- E12: Detected AC output voltage is too high, please contact the factory for processing.
- E13: When this error appears, please contact the factory for processing.

Protection Modes:

This unit features a range of inbuilt safety features to help protect both this unit, and devices connected to it. These protection features include the following.

- Low-Voltage Protection: to protect the battery from over-discharge. When the battery is running out of power, the DC output will automatically turn off. Please ensure that the unit is sufficiently charged.
- Over-Voltage Protection: to protect the electric appliance from burnout. When the battery voltage is detected as too high, the DC output will automatically turn off. And please return it to factory for processing.
- DC Over-Current Protection: when the total current of DC electric appliances exceeds the maximum allowable current, the DC output will automatically turn off. Please remove some of electric appliances and restart the unit.
- DC Short-Circuit Protection: when the DC output is short-circuited or overpowered, the DC output will automatically turn off. Please resolve the problem and restart the unit.

【 V 】 USB OUTPUT

This unit has 2x USB-A (5V/2.4A) outputs, 1x USB-A QC3.0 Quick Charge output, and 1x TYPE C PD3.0 output. Connect the USB cable of the electric appliance to the USB outlet of the unit (as below). Switch on the "DC button", the USB indicator on the LCD display panel will light up, and the unit will start charging your SV appliances such as smart phones, tablets, Bluetooth speakers, etc.

☆ NOTE: When all DC and USB appliances are removed, the DC output will automatically switch off after 30 seconds, and the unit will enter a low power state.

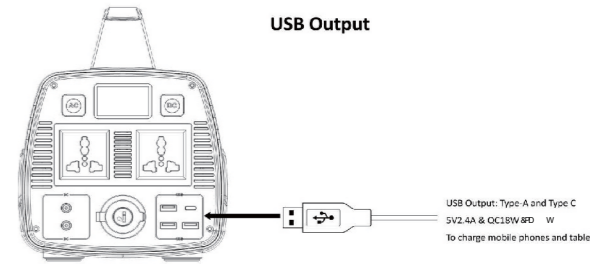

Protection Modes:

- Low-Voltage Protection: to protect the battery from over-discharge. When the battery is running out of power, the USB output will automatically turn off. Please ensure that the unit is sufficiently charged.
- Over-Voltage Protection: to protect the electric appliance from burnout. When the battery voltage is detected as too high, the USB output will automatically turn off. Please return it to factory for processing.
- USB Over-Current Protection: when the USB current exceeds the maximum allowable current, the USB output will automatically turn off. Please remove the electric appliance, and it will restore automatically.
- USB Short-Circuit Protection: when the USB output is short-circuited, the USB output will automatically turn off. It will automatically restore after the load is removed.
- Over-Temperature Protection: during the use of USB output, when the output voltage is large and temperature becomes high, the USB output will automatically turn off. After the temperature drops, USB output will restore automatically.

【 X 】 MAINTENANCE AND SECURITY

- Use the unit properly to avoid electric shock.
- Do not charge the unit with a charger that doesn't match this product.
- Keep the unit away from high temperature, high humidity, high salinity and corrosive environments.
- Do not expose the unit to direct sunlight, or dispose of it in fire.
- Do not place or store the unit together with bulk metal objects.
- Do not disassemble or reassemble this unit.
- Do not intentionally knock, impact, pierce or drop this product.
- Do not store the unit for a long time under power loss.
- Do not cover the unit with towels, clothing and other items, so as not to affect heat dissipation.
- Do not connect the unit with a charger for a long time.
- Children should be supervised to ensure that they do not play with this unit.
- Please scrap and recycle this unit in accordance with the regulations.
- This unit is designed for temporary outdoor and emergency use only. It cannot replace normal alternating current supply.
- This unit provides a pure sine wave output, compatible with all appliances less than 500W in the market.

【XI】STORAGE AND TRANSPORTATION

- The preservation temperature of this unit is -20°C ~ +50°C, to ensure the safety of product storage, please keep it in a dry and cool environment.
- If the unit is not to be used for a long time, please disconnect all cables and store safely.
- If the unit is to be stored for an extended period, it's best to charge within 3 months and charge at least once within 6 months, so as to extend the life of the unit.
- When storing and transporting, please place the unit in the correct direction.
- Securely take care when transporting the unit. Do not drop it and do not press it heavily. Ensure that it is securely restrained in any vehicle.

【XII】RECYCLING

This product is made of lead free materials, and it's difficult to degrade naturally. In the process of degradation, it will cause certain pollution to the environment, and produce precious metals and rare metals. To protect the environment and make good use of natural resources, please return your used electronic products, batteries and packaging materials to dedicated collection points.

【STATEMENT】

Our company is the only manufacturer of this product and user manual, and applies for various patents. Without the permission of our company, no individual or unit may imitate, reproduce or extract without authorization. Violators will be held liable for the corresponding legal liability. This user manual will be updated from time to time based on the product version upgrade, unless otherwise stated. Please refer to our website for any updated versions. Please use this unit strictly in accordance with this user manual. If any accidents caused by violating indication requirements, user bear the consequences.

