

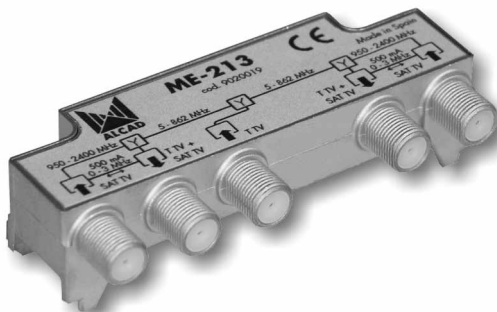

MEZCLADORES TV-SAT
TTV-SAT MULTIPLEXERS
COUPLEURS TVT-SAT



SERIE 902 SERIES

| CÓDIGO-CODE-CODE | | 9020045 | |
|---|------|------------|-----------|
| MODELO-MODEL-MODELE | | MM-214 | |
| Conector Connector Connecteur | | F | |
| Número de entradas Number of inputs Nombre d'entrées | | 2 | |
| Rango de frecuencia Frequency range Gamme de frequences | Band | FM/TV | SAT |
| | MHz | 5 - 862 | 950 -2400 |
| Atenuación de inserción Insertion loss Attenuation d'insertion | dB | 1±0,5 | 1±0,5 |
| Rechazo entre entradas Rejection between inputs Rejection entre entrées | dB | ≥ 35 | |
| Paso de corriente Dc path Passage d'alimentation | mA | - | 0 - 500 |
| | MHz | - | 0 - 3 |
| Paso 22 KHz/DiSEqC Pass 22 KHz/DiSEqC Passage 22 KHz/DiSEqC | | - | • |
| Temperatura de funcionamiento Operating temperature Temperature de fonctionnement | °C | -10 .. +65 | |
| Índice de protección Protection index Indice de protection | | IP 53 | |

MM-214

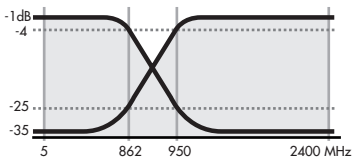
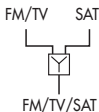

| CÓDIGO-CODE-CODE | | 9020015 | | 9020019 | | |
|---|------|------------|------------|---------|----------|----------|
| MODELO-MODEL-MODELE | | ME-214 | | ME-213 | | |
| Conector Connector Connecteur | | F | | | | |
| Número de entradas Number of inputs Nombre d'entrées | | 2 | | 3 | | |
| Rango de frecuencia Frequency range Gamme de frequences | Band | FM/TV | SAT | FM/TV | SAT1 | SAT2 |
| | MHz | 5 - 862 | 930 - 2400 | 5 - 862 | 950-2400 | 950-2400 |
| Atenuación de inserción Insertion loss Attenuation d'insertion | dB | 1±0,5 | 1±0,5 | 4±1,0 | 1±0,5 | 1±0,5 |
| Rechazo entre entradas Rejection between inputs Rejection entre entrées | dB | ≥ 35 | | | | |
| Paso de corriente Dc path Passage d'alimentation | mA | - | 0 - 500 | - | 0 - 500 | 0 - 500 |
| | MHz | - | 0 - 3 | - | 0 - 3 | 0 - 3 |
| Paso 22 KHz/DiSEqC Pass 22 KHz/DiSEqC Passage 22 KHz/DiSEqC | | - | • | - | • | • |
| Temperatura de funcionamiento Operating temperature Temperature de fonctionnement | °C | -10 .. +65 | | | | |
| Índice de protección Protection index Indice de protection | | IP 53 | | | | |

ME-214

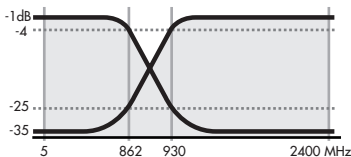
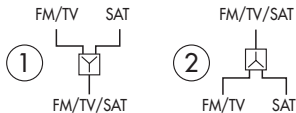

ME-213

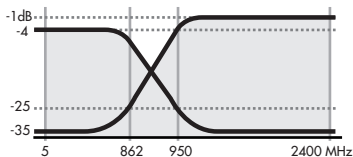
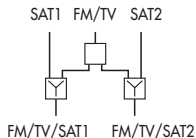

ESQUEMAS TÍPICOS
 CONNECTION DIAGRAMS
 SCHEMAS DE CONNEXION

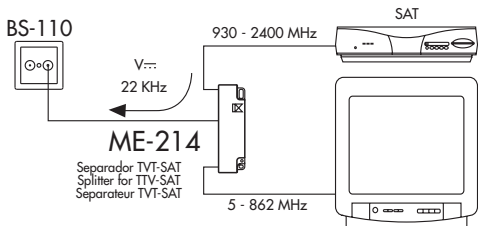
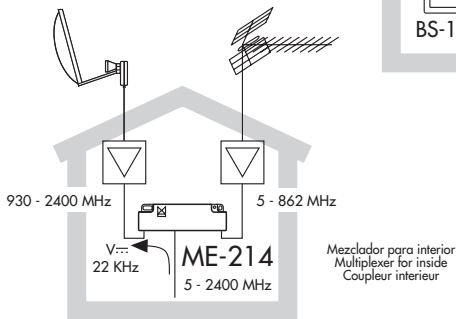
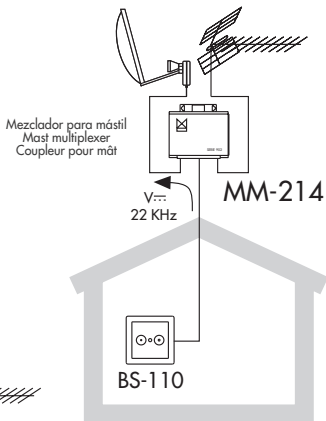

ESQUEMA TÍPICO
CONNECTION DIAGRAMS
SCHEMAS DE CONNEXION

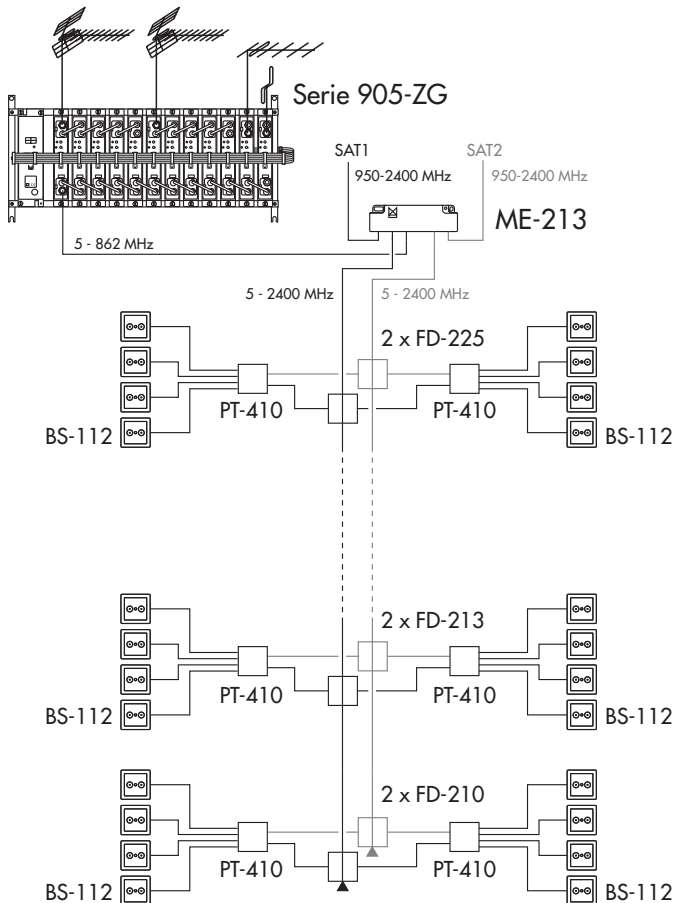

Especificaciones sujetas a modificación sin previo aviso
Specifications subject to modifications without prior notice
Les spécifications sont soumises à de possible modifications sans avis préalable



ALCAD Electronics, S.L.
Pol. Ind. Arreche-Ugalde, 1
Apdo. 455 | 20305 IRUN - Spain
Tel. (+34) 943 63 96 60
info@alcad.net