

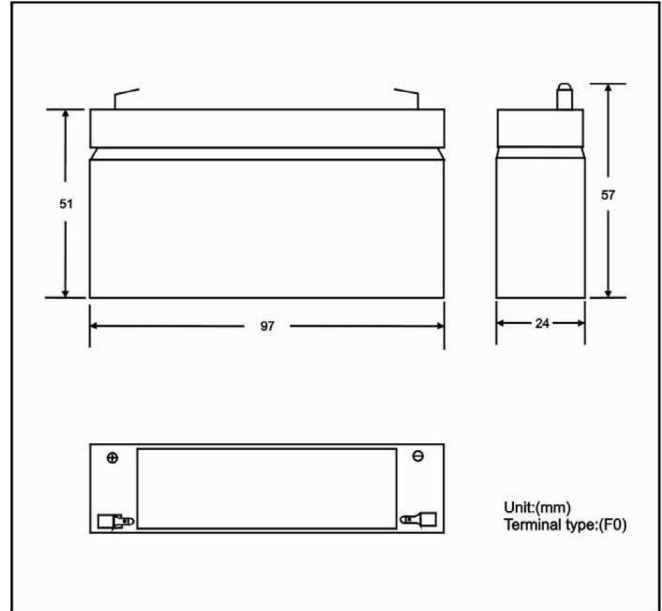

Akumulator żelowy VIPOW 6V 1.3Ah



Specifications

LP1.3-6		
Nominal Voltage		6V
Rated Capacity (20 hours rate)		1.3Ah
Dimension (±2mm)	Total Height (with terminals)	57mm
	Length	97mm
	Width Height	24mm 51mm
Weight (Approx)		0.3Kg

Characteristics

Capacity	20 hours rate (0.065A)	1.3Ah
Discharge Current Testing (25°C)	20 I ₂₀ rate (1.3A, 27min) 60 I ₂₀ rate (3.9A, 7min)	36min 8.5min
Internal Resistance	Full Charged Battery 25°C	65mΩ
Capacity Affected By Temperature (20 hours rate)	40°C 25°C 0°C -15°C	102% 100% 85% 62%
Residual Capacity (25°C)	Capacity After 3 Months Storage Capacity After 6 Months Storage Capacity After 12 Months Storage	91% 82% 64%
Cycle (Above 300 Time)	Discharge 2hrs at 0.325A Current Charge 6hrs at 0.13A Current (25°C)	
Charge (Constant Voltage)	Cycle (25°C)	Initial Charging Current Less Than 0.39A; Voltage 7.25~7.45V
	Float (25°C)	Charge Voltage 6.8~6.9V

★ The above are average and date obtained from the first 3 charge/discharge cycles. These are not minimum values.

Discharge Current & Duration Time

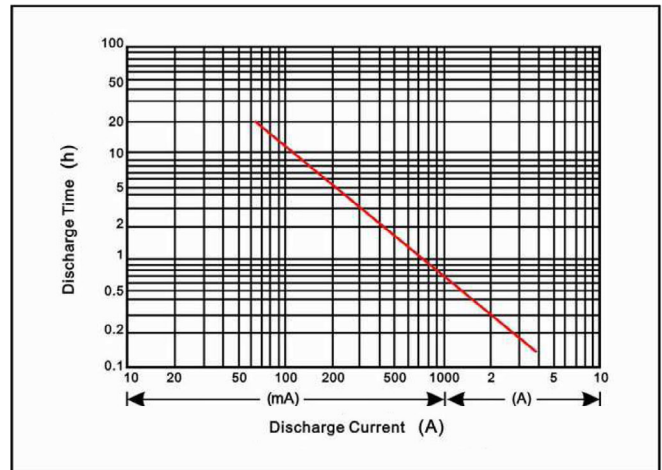

Discharge Current 25°C

