

UNI-T



P/N:110401108918X



UTi80P
Compact Thermal Imager

Preface

Thank you for purchasing the new UTi80P thermal imager. In order to use this product safely and correctly, please read this manual thoroughly, especially the Safety Instructions part.

After reading this manual, it is recommended to keep the manual at an easily accessible place, preferably close to the device, for future reference.

Limited warranty and liability

Uni-Trend guarantees that the product is free from any defect in material and workmanship within one year from the purchase date. This warranty does not apply to damages caused by accident, negligence, misuse, modification, contamination and improper handling. The dealer shall not be entitled to give any other warranty on behalf of Uni-Trend. If you need warranty service within the warranty period, please contact your seller directly.

Uni-Trend will not be responsible for any special, indirect, incidental or subsequent damage or loss caused by using this device. As some countries or regions do not allow limitations on implied warranties and incidental or subsequent damages, the above limitation of liability may not apply to you.

Table of Contents

1. Introduction	3
2. Safety Instructions	3
3. Structure	4
4. Display	5
5. Menu Introduction and Operation	6
6. USB Communication	16
7. Specifications	17
8. Maintenance	19
9. Appendix	19

1. Introduction

The UTi80P thermal imager is a pocket-sized and lightweight device. This device is able to find hidden hot spots, energy loss, structural defects, pipe jams, HVAC faults and other problems through analyzing the thermal image of a surface. It can measure temperatures up to 400°C and quickly displays the result on the LCD screen. With data recording, analyzing, and report generating functions, the UTi80P is an ideal measurement tool for professional fields requiring temperature analysis.

2. Safety Instructions

To ensure accurate measurement results, please read the instructions carefully.

Please be sure to use this product in accordance with the instructions, otherwise the free warranty will be voided if the product is damaged.

Please do not use this product in flammable, explosive, steamy, wet or corrosive environments.

Please stop using the product if it is damaged or modified to avoid inaccurate test results.

Please use the correct emissivity value in order to obtain accurate temperature readouts.

To ensure the accuracy of the product, please warm it up for 10 minutes before measuring if it has not been used for a long time.

When being charged, the internal temperature of the product will rise, which will lead to inaccurate temperature measurement. So, it is not recommended to be used for testing while or right after the product is being charged.

3. Structure

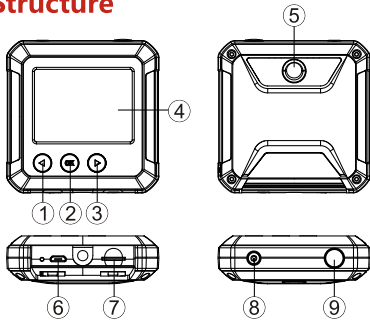

Item	Description
1	Left button/Temperature calibration button
2	OK/Menu button
3	Right button/ Fast thermal tracking toggle
4	LCD
5	Infrared thermal image window
6	USB interface
7	Micro SD card slot
8	Power button (long press to turn on/off)
9	Picture taking/Back button

4. Display

Display size: 2.4" (495mm x 377mm)
 Display resolution: 320 x 240 pixels

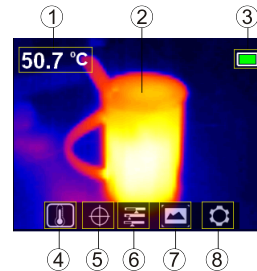

Item	Description
1	Measured temperature
2	Thermal image display area
3	Battery level
4	"Temperature" option
5	"Cursor" option
6	"Color palette" option
7	"Picture playback" option
8	"Settings" option

5. Menu Introduction and Operation

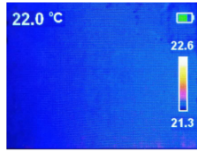

Thermal image display page

Main Menu and submenu

Main Menu

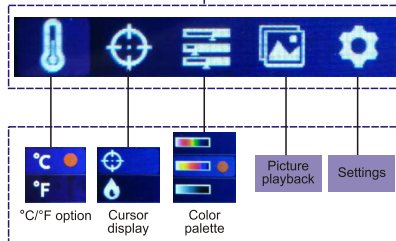

Submenu



Center point position

High/Low temperature tracking

a. Picture Taking

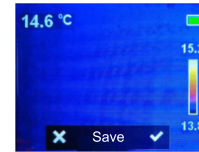

1. Press the picture taking button to photograph the current image.
2. Press the right button to save the picture.
3. Press the left button to discard the picture.

Note: It is recommended to store no more than 5000 images, so as not to affect the image storage speed.

b. Temperature Unit Selection

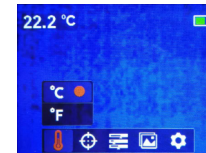



1. Press the OK button to pop-up the main menu.
2. Press the left/right button to select the option.
3. Press the OK button to enter the temperature submenu.
4. Press the left/right button to select °C or °F.
5. Press the back button to exit the current menu.



c. Center Point and High/Low Temperature Tracking



To track the temperature of center point:

1. Press the OK button to pop up the main menu.
2. Press the left/right button to select the  option.
3. Press the OK button to enter the submenu.
4. Press the left/right button to select the  option.
5. Press the OK button to confirm it.
6. Press the back button to exit the current menu.

To track high/low temperatures:

1. Press the OK button to pop up the main menu.
2. Press the left/right button to select the  option.
3. Press the OK button to enter the submenu.
4. Press the left/right button to select the  option.
5. Press the OK button to confirm it.
6. Press the back button to exit the current menu.

Note:

In the image display page, the temperature value displayed in the top left corner of the LCD is the temperature of the center point, and the temperature value displayed in the top/bottom area of the color bar on the right side of the LCD is the high/low temperature.

d. Color Palette Selection



1. Press the OK button to pop up the main menu.
2. Press the left/right button to select the  option.
3. Press the OK button to enter the color palette submenu.
4. Press the left/right button to select the desired color from iron red, rainbow and grey.
5. Press the back button to exit the current menu.

In addition, in the image display page, press the right button to switch between the current color image and fast thermal tracking image.

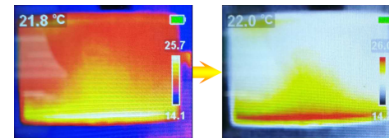

Iron red image

Fast thermal tracking image

Note: The fast thermal tracking image cannot be switched to iron red, rainbow or grey image by color selection.

e. Picture Playback



To playback a picture:

1. Press the OK button to pop up the main menu.
2. Press the left/right button to select the picture playback option.
3. Press the OK button to enter the submenu.
4. Press the left/right button to select the picture to view.
5. Press the back button to exit the current menu.

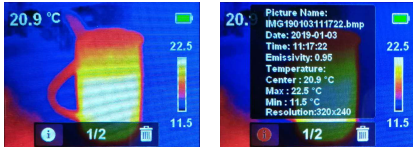

To view detailed information of the picture:

1. Enter the picture playback submenu.
2. Press the OK button to pop up [OK] and [INFO].
3. Press the left/right button to select the [INFO] option.
4. Press the OK button to display detailed information of the picture.
5. Press the back button to exit the current menu.

10



To delete the picture:

1. Enter the picture playback submenu.
2. Press the OK button to pop up [OK] and [DELETE].
3. Press the left/right button to select the [DELETE] option.
4. Press the OK button to pop up the dialog box asking whether to delete the picture.
5. Press the left/right button to select ✓ or ✕.
6. Select ✓ to delete the picture and return to the picture playback submenu.
7. Select ✕ to directly return to the picture playback submenu.
8. Press the back button to exit the current menu.

f. Settings

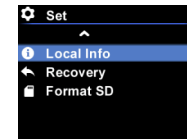
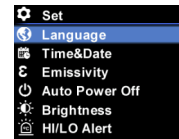

To enter the Settings menu:

1. Press the OK button to pop up the main menu.
2. Press the left/right button to select the [SETTINGS] option.
3. Press the OK button to confirm the [SETTINGS] option.

11

I. Language

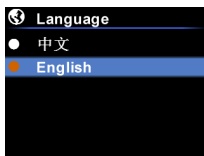

To change the language:

1. Select the Language option (left/right button) from settings menu.
2. Press the OK button to enter the Language submenu.
3. Press the left/right button to select the desired language (Chinese or English).
4. Press the OK button to confirm it.
5. Press the back button to exit the current menu.

ii. Date and Time



To set the date and time:

1. Select the Time&Date option (left/right button) from settings menu.
2. Press the OK button to enter the Time&Date submenu.
3. Press the left/right button to select the time or date parameter to be adjusted.
4. Press the OK button to enter the parameter adjustment state.
5. Press the left/right button to add or subtract the value.
6. Press the OK button to save the settings.
7. Press the back button to exit the current menu.

12

iii. Emissivity

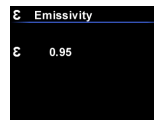

To set the emissivity:

1. Select the Emissivity option (left/right button) from settings menu.
2. Press the OK button to enter the Emissivity submenu.
3. Press the OK button again.
4. Press the left/right button to adjust the emissivity.
5. Press the OK button to save the settings.
6. Press the back button to exit the current menu.

Note:

The emissivity value can be adjusted from 0 to 0.99.
The default value is set to 0.95.

Selecting the correct emissivity value is very important for accuracy of temperature measurement, as the emissivity has a significant impact on the measured surface temperature.

For emissivity values of common materials, please refer to the common emissivity table in the appendix.

iv. Auto Power Off

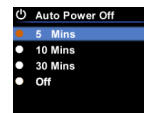

To set auto power off:

1. Select the Auto Power Off option (left/right button) from settings menu.
2. Press the OK button to enter the Auto Off submenu.
3. Press the left/right button to select the desired auto power off time.
4. Press the OK button to confirm it.
5. Press the back button to exit the current menu.

13

v. Display Brightness

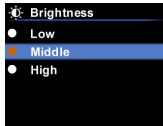

To set the display brightness:

1. Select the Brightness option (left/right button) from settings menu.
2. Press the OK button to enter the Brightness submenu.
3. Press the left/right button to select the desired brightness.
4. Press the OK button to confirm it.
5. Press the back button to exit the current menu.

vi. High/Low Temperature Alarm

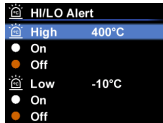

To set the high/low temperature alarm:

1. Select the High/Low Temperature Alarm option (left/right button) from settings menu.
2. Press the OK button to enter the High/Low Temperature Alarm submenu.
3. Press the left/right button to select the desired option.
4. Select High/Low to adjust the temperature parameter.
5. Select other options to turn the alarm on or off.
6. Press the back button to exit the current menu.

14

vii. Device Information



To view the device information:

1. Select the Device Information option (left/right button) from settings menu.
2. Press the OK button to view the detail information of the device.
3. Press the back button to exit the current menu.

viii. Restore Settings

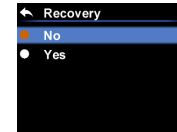

To restore settings:

1. Select the Recovery option (left/right button) from settings menu.
2. Press the OK button to enter the Recovery submenu.
3. Press the left/right button to select Yes or No.
4. Press the OK button to confirm it.
5. Press the back button to exit the current menu.

15

ix. Format SD Card

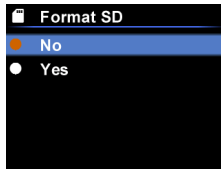

To format the SD card:

1. Select the Format SD option (left/right button) from settings menu.
2. Press the OK button to enter the Format SD submenu.
3. Press the left/right button to select Yes or No.
4. Press the OK button to confirm it.
5. Press the back button to exit the current menu.

6. USB Communication

1. Download and install the PC software (refer to UNI-T Documents Download Operation Guide).
2. After opening the PC software, connect the USB cable to the computer.
3. Users can browse pictures and analyze data through the PC software. Regarding the use of the computer software, users can retrieve the Software User Manual from the Help option of the operation interface.

7. Specifications

Temperature range	-10°C~400°C
Basic accuracy	-10°C~400°C: $\pm 2.0^{\circ}\text{C}$ or $\pm 2\%$ of reading, whichever is greater (room temperature: 25°C)
Emissivity	0.95 default (0.1~0.99 adjustable)
Measurement resolution	0.1°C/0.1°F
Response time	$\leq 500\text{ms}$
IR resolution	4800 pixels (80*60)
Pixel size	17 μm
Color palette	Rainbow, iron red, grey, fast thermal tracking
Wavelength range	8 μm ~14 μm
Field of view (FOV)	51°(H) * 38°(V)
Thermal sensitivity	$\leq 150\text{mk}$
Frame rate	$\leq 9\text{Hz}$
Image format	Bitmap (BMP) image (320 x 240 pixels)

General parameters

Product size (L x W x H)	76mm x 76mm x 24mm
Display type	2.4" TFT LCD
Display resolution	320*240 pixels
Battery	3.7V/1300mAh rechargeable lithium battery
Auto power off	√
Battery life	≥3.5 hours
Charging time	2 to 2.5 hours
Certification	CE
Storage card	16GB Micro SD card
Storage temperature	-20°C~60°C (-4°F~140°F)
Operating temperature	0°C~50°C (32°F~122°F)
Drop test	1m
Standard accessories	User manual, USB cable, 16GB Micro SD card
Altitude	≤2000m

8. Maintenance

Use a wet cloth or weak soap solution to clean the outer shell of the device.

Do not use abrasives, isopropyl alcohol or solvents to clean the lens and window.

Note: The inherent temperature drift of the sensor will occasionally cause inaccurate measurement. In this case, press the left button under the temperature measurement interface to bring out "Calibrating" and automatically calibrate the temperature.

9. Appendix

Emissivity of common objects

Material	Emissivity	Material	Emissivity
Wood	0.85	Black paper	0.86
Water	0.96	Polycarbonate	0.8
Brick	0.75	Concrete	0.97
Stainless steel	0.14	Copper oxide	0.78
Tape	0.96	Cast iron	0.81
Adhesive tape	0.09	Rust	0.8
Copper plate	0.06	Gypsum	0.75
Dark aluminum	0.95	Paint	0.9
Human skin	0.98	Rubber	0.95
Asphalt	0.96	Soil	0.93
PVC material	0.93		

Note: This manual can be downloaded from the official website of Uni-Trend (refer to UNI-T Documents Download Operation Guide).

UNI-T

UTi80P User Manual

UNI-T

UNI-TREND TECHNOLOGY (CHINA) CO., LTD.

No. 6, Gong Ye Bei 1st Road,
Songshan Lake National High-Tech Industrial
Development Zone, Dongguan City,
Guangdong Province, China
Tel: (86-769) 8572 3888
www.uni-trend.com