

UNI-T®

UT701



Operating Manual



Temperature Calibrator



P/N:110401107854X

Contents

1. Introduction	1
2. Accessories	1
3. Safety Guidelines	2
4. Electrical Symbols	3
5. General Specifications	3
6. External Structure	4
7. LCD Display	7
8. Basic Operation and Functions	8
9. Advanced Applications	17
10. Technical Specifications	20
11. Maintenance	22

1. Introduction

UT701 is a hand-held temperature calibrator with stable performance and high accuracy. It can provide voltage, resistance, 10 kinds of thermocouple and 4 kinds of RTD outputs. The thermocouple outputs are designed with automatic and manual cold junction temperature compensation. UT701 also features automatic stepping and ramping, the 25% stepping function can be used for fast linearity detection, and the store/recall feature improves user's efficiency.

Features

- 1) Up to 0.05% output and measurement accuracy
- 2) Compact and ergonomic design, easy to carry
- 3) Solid and reliable, suitable for on-site use
- 4) Auto stepping and ramping output for fast linearity detection
- 5) Save frequently-used settings for future use
- 6) Adjustable backlight brightness
- 7) Convenient battery replacement

2. Accessories

Open the package box and take out the device. Please check whether the following items are deficient or damaged, and contact your supplier immediately if they are.

- 1) User manual ----- 1 pc
- 2) Test leads ----- 1 pair
- 3) Alligator clip ----- 1 pair
- 4) 9V battery ----- 1 pc
- 5) Warranty card ----- 1 pc

3. Safety Guidelines

3.1 Safety Certification

CE (EMC, RoHS) certification standards

EN 61326-1: 2013 Electromagnetic compatibility (EMC) requirements for measuring equipment

EN 61326-2-2: 2013

3.2 Safety Instructions

Please use the calibrator only as specified in this manual, otherwise the protection provided by the calibrator may be impaired or lost. To avoid electric shock or personal injury:

- Output a certain voltage to confirm the calibrator is working properly before use.
- Please follow all safety operation instructions.
- Select the proper function and range according to the measurement requirements.
- Before using the calibrator, make sure the battery cover is closed.
- Remove the test leads on the calibrator before opening the battery cover.
- Check the test leads for damage or exposed metal, and check the test leads continuity. Replace the damaged test leads before use.
- When using the probes, do not touch the metal part of the probes. Keep your fingers behind the finger guards on the probes.
- Connect the common test lead and then the live test lead when wiring. Remove the live test lead first when disconnecting.
- Do not use the calibrator if there is any malfunction, the protection might be impaired. Please send the calibrator for maintenance.
- Do not use the calibrator near explosive gases.
- Remove the test leads before switching to other measurements or outputs.
- To avoid possible electric shock or personal injury caused by incorrect readings, replace the battery immediately when the low battery indicator appears on the screen.

4. Electrical Symbols

	Double insulated
	Warning
	Conforms to European Union directives

5. General Specifications

- 1) Display count: 200000
- 2) Range: manual
- 3) Operating temperature: 0°C~50°C (32°F~122°F)
- 4) Storage temperature: -20°C~70°C (-4°F~158°F)
- 5) Relative humidity: 0°C~below 30°C: ≤75%; 30°C~40°C: ≤50%
- 6) Operating altitude: 0~2000m
- 7) Battery: 9V×1
- 8) Dimension: about 96×193×47mm
- 9) Weight: about 370g (including battery)
- 10) EMC:
RF field (3V/m): overall accuracy = specified accuracy + 5% of range
RF field (>3V/m): no specified calculation

6. External Structure

6.1 Connectors (Terminals) (picture 1)

Serial No.	Name	Description
1	4W	Resistance 4-wire output
2	V/mV/R/TC/ RTD terminal	Volt, millivolt, resistance, TC (thermocouple), or RTD (resistance temperature detector) output terminal
3	COM terminal	Common terminal for all output functions
4	3W	Resistance 3-wire output

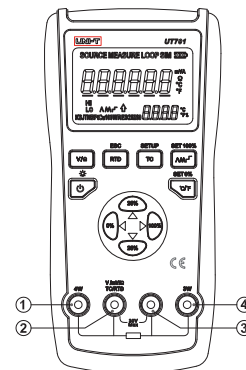

Picture 1

6.2 Buttons (picture 1a)

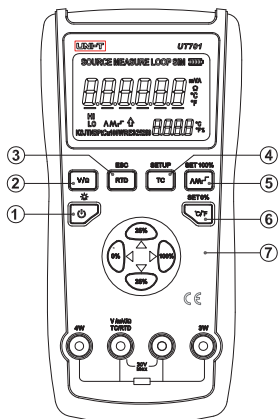

Picture 2

No.		Description
1		Power on/off (long press)
		Backlight on/off (short press)
2		Short press to switch between voltage output and resistance output
		Long press to view the mV value or resistance value under TC or RTD mode

3		Short press to select the RTD output mode. Keep pressing to cycle through the RTD types
		Long press to restore factory settings: restore the auto cold junction temperature compensation under RTD output mode
4		Short press to select the TC output mode. Keep pressing to cycle through the thermocouple types
		Long press to set and save the calibrator parameters
5		Cycles through (short press): Continuously outputs 0%-100%-0% with a low slope (slow), and repeats the operation automatically; Continuously outputs 0%-100%-0% with a high slope (fast), and repeats the operation automatically; Outputs 0%-100%-0% in 25% step size, and repeats the operation automatically.
		Long press to set 100% value
6		Short press to switch between °C/°F in thermocouple/RTD mode
		Long press to set 0% value
7		Short press to manually adjust the output setting value
		Long press to output 0% value of the currently set range
		Long press to decrease output by 25% of range
		Long press to increase output by 25% of range
		Long press to output 100% value of the currently set range

Note: Short press time: <1.5s. Long press time: >1.5s.

7. LCD Display (picture 2)

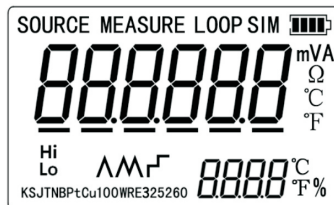

Picture 2

Symbols	Description
SOURCE	Source output indicator
—	Digit selecting indicator
	Battery power indicator
Hi	Indicates that the excitation current is too large
Lo	Indicates that the excitation current is too small
ΛMΓ	Ramp/step output indicators
E, J, K, T, B, R, S, N, Wre325, WRe526	Thermocouple output indicators
Pt10, Pt100, Cu50, Cu100	RTD output indicators
Ω	Resistance unit: Ω, kΩ, MΩ
mV	Voltage unit: mV, V
%	Percentage indicator of source/measurement value
°C/°F	Temperature unit: Celsius, Fahrenheit

8. Basic Operations and Functions

8.1 Basic Operations

8.1.1 Source

The purpose of this section is to introduce some basic operations of UT701.

Follow the steps below for the DC voltage output:

- 1) Connect the red test lead to V terminal, black to COM terminal; then connect the red probe to positive terminal of voltmter, black to negative terminal.

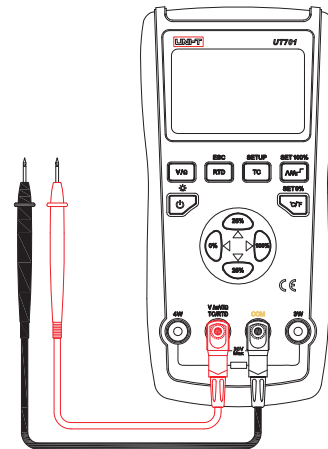

Picture 1.1-1 Output terminals

- 2) Press  (>2s) to turn on the calibrator and it will perform self-test, which includes the internal circuit and LCD display testing. The LCD screen will display all symbols for 1s during self-test. The interface is shown below:

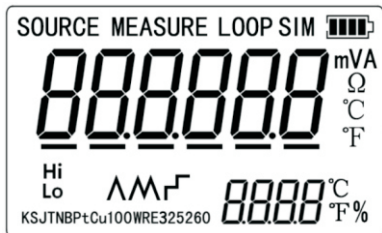

Picture 1.1-2 Full symbol display

- 3) Next the product model and the auto power off time are displayed for 2s, as shown below:

- 4) Then the default main interface is displayed, as shown in the following figure:

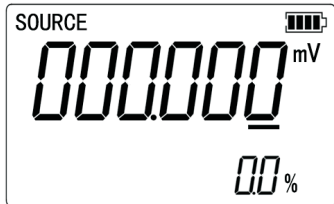

Picture 1.1-3 Displays model and auto power off time Picture 1.1-4 mV (100mV) range output

- 5) Press  to switch to mV high-range output, press again to switch to resistance output, and so on. See the following picture for the display.

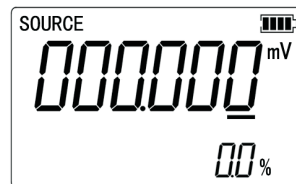

Picture 1.1-5 Voltage output 100mV











Picture 1.1-6 Voltage output 1000mV









Picture 1.1-7 Resistance output 5000Ω



Picture 1.1-8 Resistance output 500Ω

- a) Press  or  to add or subtract 1 for the value above the underline (the value is automatically carried and the position of the underline remains unchanged); press  or  to change the position of the underline.
- b) Long press  until the buzzer beeps, 0mV can be used as the value of 0%.
- c) Similarly, use  buttons to increase the output to 100.0 mV; long press  until the buzzer beeps, 100mV can be used as the value of 100%.
- d) Long press  or  to increase or decrease the output between 0% and 100% in 25% steps, as shown in the figure below.

8.1.2 Auto Power Off

- The calibrator will automatically shut down if there is no button or communication operation within the specified time.
- Auto power off time: 30min (factory setting), which is enabled by default and is displayed for about 2s during the booting process.
- To disable "auto power off", press down  while turning on the calibrator until the buzzer beeps. To enable "auto power off", press down  while turning on the calibrator until the buzzer makes a "beep" sound.
- To adjust the "auto power off time", press down  while turning on the calibrator until the buzzer beeps, then adjust the time between 1~30 min with ,  buttons, short press  to save settings (if the time is not saved, the calibrator will exit settings automatically in 5s after pressing the buttons), ST will flash and then enter the operating mode.

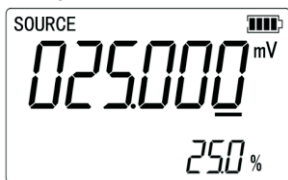

Picture 1.1-9 25% step size





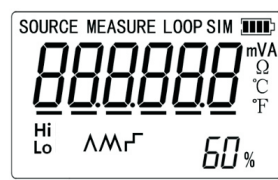

Picture 1.2-1 Save settings



Picture 1.3-1 Screen brightness setup

8.1.3 LCD Backlight Brightness Control





Steps:

- 1) Press down  while turning on the calibrator until the buzzer makes a "beep" sound, as shown below:
- 2) Then adjust the backlight brightness by ,  buttons, the brightness value is displayed on the screen.
- 3) Short press  to save settings, ST will flash and then enter the operating mode. If the settings are not saved, the calibrator will exit settings automatically in 5s after pressing the buttons (will not save the current setting value).

8.2 Functions

8.2.1 Voltage Output

Steps:

- 1) Short press  and select voltage output, LCD displays 'mV' unit, then select the corresponding range as required.
- 2) Connect the red test lead to V terminal, black to COM terminal.
- 3) Connect the red probe to positive end of the voltmeter, black to negative end of the voltmeter.
- 4) Select an output digit by ,  buttons, and adjust its value with ,  buttons.
- 5) Read the data on the voltmeter.

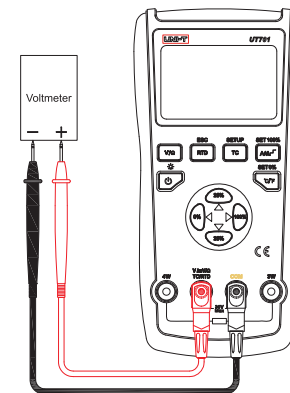

Picture 2.1-1 Voltage output connection

8.2.2 Resistance Output

Steps:

- 1) Short press **[VΩ]** and select resistance output, LCD displays 'Ω' unit, then select the corresponding range as required.
- 2) Connect the red test lead to V terminal, black to COM terminal (Connection method is as follows).
- 3) Select an output digit by **[0]** **[1]** buttons, and adjust its value with **[20%** **[30%** buttons.

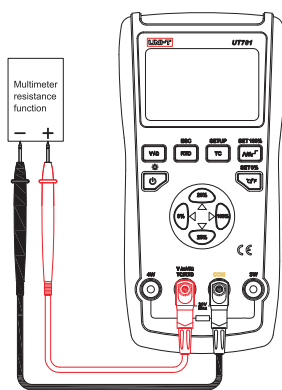

Picture 2.2-1(1)
Resistance output connection

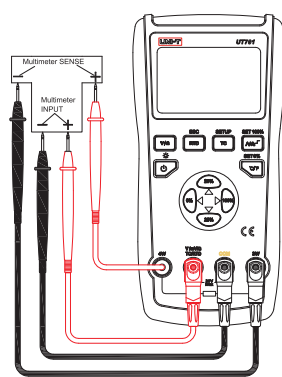

Picture 2.2-1(2)
Resistance 4-wire output connection

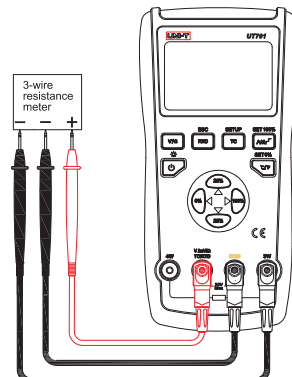

Picture 2.2-1(3)
Resistance 3-wire output connection

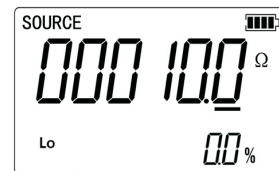

Picture 2.2-2

Lo symbol indicates that the excitation current is too small and the main display value will flash.



Picture 2.2-3

Hi symbol indicates that the excitation current is too large and the main display value will flash.

8.3 Simulating Temperature Sensors

8.3.1 Simulating Thermocouples (TC)

Connect the calibrator output to the instrument being measured with thermocouple wires according to the figure below, and simulate the thermocouple as follows:

- 1) Short press **[TC]** to choose the thermocouple function, LCD will display '°C' unit. Keep pressing this button to select the required thermocouple type.
- 2) Connect the thermocouple wires to the calibrator as shown below: connect the red test lead to TC terminal, black to COM terminal.
- 3) Select an output digit by **[0]** **[1]** buttons, and adjust its value with **[20%** **[30%** buttons.

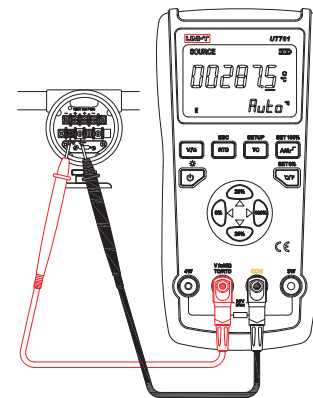

Picture 3.1-1

8.3.2 Thermocouple Cold Junction Temperature Compensation

Simulating thermocouples includes auto and manual cold junction temperature compensation. The auto cold junction compensation directly adopts the cold junction temperature of the device; and for the manual compensation, users can input the custom cold junction temperature through buttons.

8.3.2.1 Auto Cold Junction Temperature Compensation

When entering the thermocouple output mode for the first time, the default method of cold junction temperature compensation is auto, as shown in the figure. To view the current value of auto cold junction temperature compensation, long press **RTD** button, and the Auto symbol is replaced by the current value of 20.3, which will last for 2s and then automatically returns to Auto display.



Picture 3.2-1 Auto cold junction temperature compensation



Picture 3.2-2 Current value of cold junction temperature compensation

8.3.2.2 Manual Cold Junction Temperature Compensation

Users can enter the required cold junction temperature through buttons. The specific steps are as follows:

- 1) Long press **TC** to enter the manual cold junction compensation setting mode, as shown in the figure. The sub-display value of 23.0°C is the manual cold junction compensation value.
- 2) Adjust the manual compensation value by **▲**/**▼** buttons.
- 3) Long press **TC** to save the manual compensation value, device will automatically return to the thermocouple output mode, as shown below.
- 4) If necessary, long press **RTD** to restore to auto compensation mode.



Picture 3.3-1



Picture 3.3-2

8.3.3 Simulating Resistance Temperature Detectors (RTD)

Connect the calibrator to the instrument being measured according to the figure below, and simulate the RTD as follows:

- 1) Press **RTD** to select the RTD type.
- 2) Connect the thermocouple wires to the calibrator as shown below: connect the red test lead to TC terminal, black to COM terminal.
- 3) Select an output digit by **←**/**→** buttons, and adjust its value with **▲**/**▼** buttons.

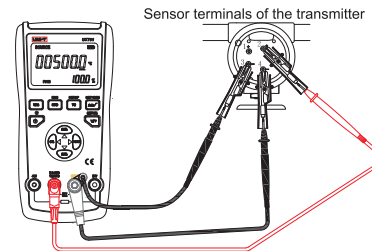

Picture 3.4-1

Note: The calibrator can simulate a 2-wire RTD output on the front panel. To connect to a 3-wire or 4-wire transmitter, use stacking cables to provide additional wiring.

8.3.4 °C/°F Display

In temperature mode, short press  to switch between °C/°F.



Picture 3.5-1 °C temperature display



Picture 3.5-2 °F temperature display

9. Advanced Applications



9.1 Setting 0 % and 100 % Output Parameters





Users need to set the values of 0% and 100% for the step operation and percentage display. Some values of the calibrator have been set before delivering. The table below lists the factory settings.

Output functions	0% value	100% value
mV (100mV)	0.000 mV	100.000mV
mV (1000mV)	0.0 mV	1000.0mV
Resistance 500Ω	0.0 Ω	500.0 Ω
Resistance 5000Ω	0 Ω	5000 Ω
Thermocouple type J	0.0 °C	1000.0 °C

Thermocouple type K	0.0 °C	1000.0 °C
Thermocouple type T	0.0 °C	400.0 °C
Thermocouple type E	0.0 °C	800.0 °C
Thermocouple type R	0 °C	1500 °C
Thermocouple type S	0 °C	1500 °C
Thermocouple type B	600 °C	1800 °C
Thermocouple type N	0.0 °C	1000.0 °C
WRe526	0.0 °C	2000.0 °C
WRe325	0.0 °C	2000.0 °C
Pt100	0.0 °C	500.0 °C
Pt1000	0.0 °C	400.0 °C
Cu50	0.0 °C	150.0 °C
Cu100	0.0 °C	150.0 °C

These factory settings may not be suitable for your work, you can reset them according to your requirements so that you can use the step or ramp output function and get the percentage display.

Adjust the output value with  buttons, long press  or  until the buzzer makes a “beep” sound to set the new values of 0% and 100%. The newly set range is automatically saved in the calibrator storage area, and it is still valid after restarting. Now you can use the settings to do the following:



- Long press  or  to manually step (increase or decrease) the output in 25% increments.
- Long press  or  to switch the output between 0% and 100% range.

9.2 Auto Ramping (Increase/Decrease) the Output

The auto ramping function allows you to continuously apply a varying signal from the calibrator to the transmitter, and your hands can be used to test the calibrator's response.

When you press , the calibrator will generate a continuous and repeating 0%-100%-0% ramping output.

Three types of ramping waveforms are available:

-  0%-100%-0% 40-second smooth ramp
-  0%-100%-0% 15-second smooth ramp
-  0%-100%-0% 25% step ramp, pausing 5s at each step

Press any key to exit the ramping output function.

9.3 Restore Factory Settings

To restore the following factory settings:

- Operating mode: voltage output mode
- Auto power off time: 30min (enabled)
- LCD backlight brightness: 60%
- Output range: factory default

Long press  while turning on the calibrator until the buzzer beeps. After the factory reset is completed, the calibrator will automatically enter to the operating mode.

10. Technical Specifications

All specifications are based on a one-year calibration period and applied to a temperature range of +18°C~+28°C unless otherwise specified. All specifications are assumed to obtain after 30 minutes operation.

10.1 DC mV Output

Range	Max output range	Resolution	Accuracy ± (% of reading + digits)
100mV	-10.00~125.00mV	0.001mV	0.05%+3
1000mV	0~1100.0mV	0.1mV	0.05%+3

-10°C~18°C, +28°C~55°C temperature coefficient: ±0.005%FS/°C
Max. load: 1mA or 1kΩ, select a small load

10.2 Resistance Output

Range	Max output range	Resolution	External excitation current	Accuracy ± (% of reading + digits) (Ω)
500Ω	0.0~500.0Ω	0.1Ω	0.075mA~3.0mA	0.05%+2
5000Ω	0.0~5000.0Ω	1Ω	7.5uA~0.3mA	0.05%+2

-10°C~18°C, +28°C~55°C temperature coefficient: ±0.005%FS/°C

10.3 Temperature, Thermocouple

Type	Range	Resolution	Accuracy ± (°C)
J	-200°C~0°C	0.1°C/0.1°F	1.0°C
	0°C~1200°C		0.7°C
K	-200°C~0°C	0.1°C/0.1°F	1.2°C
	0°C~1370°C		1°C
T	-200°C~0°C	0.1°C/0.1°F	1.2°C
	0°C~400°C		0.8°C
E	-200°C~0°C	0.1°C/0.1°F	0.9°C
	0°C~950°C		0.7°C
R	-20°C~0°C	1°C/1°F	2.5°C
	0°C~500°C		1.8°C
	500°C~1750°C		1.4°C
S	-20°C~0°C	1°C/1°F	2.5°C
	0°C~500°C		1.8°C
B	500°C~1750°C	1°C/1°F	1.5°C
	600°C~800°C		2.2°C
	800°C~1000°C		1.8°C
N	1000°C~1800°C	0.1°C/0.1°F	1.4°C
	-200°C~0°C		1.5°C
	0°C~1300°C		0.9°C
Wre325	0°C~2000°C	0.1°C/0.1°F	1.8°C
Wre526	0°C~2300°C	0.1°C/0.1°F	1.8°C

The error in this table does not include the error of cold junction temperature compensation.
Cold junction temperature compensation accuracy: 1.5°C

10.4 Temperature, RTD

Type	Range	Resolution	Accuracy ± (% of reading + digits)
Pt100	-200°C~850°C	0.1°C/ 0.1°F	0.05%+0.6°C
Pt10	-200°C~850°C		0.5%+6°C
Cu50	-50°C~150°C		0.05%+0.6°C
Cu100	-50°C~150°C		0.05%+0.6°C

External excitation current allowed at output: please refer to the resistance output function.

11. Maintenance

⚠ Warning: Before opening the rear cover or the battery cover, switch off the power supply and remove the test leads from the input terminals and the circuit.

11.1 General Maintenance

- * Clean the case with a damp cloth and mild detergent. Do not use abrasives or solvents.
- * If there is any malfunction, stop using the device and send it for maintenance.
- * The calibration and maintenance must be implemented by qualified professionals or designated departments.

11.2 Battery Installation and Replacement (picture 11)

Remark:

"" indicates that the battery power is less than 20%, please replace the battery in time (9V battery), otherwise the measurement accuracy might be affected.

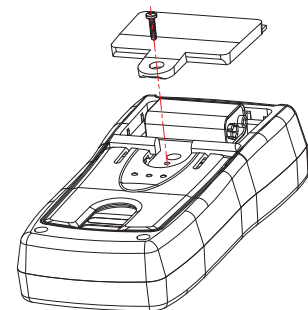

Uni-Trend reserves the rights to update the content of this manual without further notice.

UNI-T®

UNI-TREND TECHNOLOGY (CHINA) CO., LTD.

No6, Gong Ye Bei 1st Road,
Songshan Lake National High-Tech Industrial
Development Zone, Dongguan City,
Guangdong Province, China
Tel: (86-769) 8572 3888
<http://www.uni-trend.com>



彩盒 菲林做货要求：

序号	项目	内容	备注
1	尺寸	尺寸:150*118mm	
2	材质	封面128g铜板 + 内页60g书纸	
3	颜色	单色双面	
4	外观要求	完整清晰、版面整洁，无斑墨、残损、毛边、刀线错位等缺陷。	
5	装订方式	钉装	
6	表面处理		
7	其它	无	
版本		REV.0	
DWH 设计	宣浩	MODEL 机型: Ut701	Part NO. 物料编号: 110401107854X
CHK 审核		 优利德科技(中国)有限公司 UNI-TREND TECHNOLOGY (CHINA) LIMITED	
APPRO. 批准			