

UNI-T®



UT273/275

Operating Manual



Clamp Earth Ground Testers

P/N:110401104567X
DATE:2018.06.26
REV.5

Foreword

Hello, dear customers! Thanks for your purchasing our company's new instrument. To ensure correct usage, please carefully read the full text of this manual before you use this instrument, especially the related part of “Safety Notices” . In case you have completely read this manual, suggest you to keep this manual well and place it together with the instrument or where you can look up at any time, so that you can refer to it in the future.

Contents

- I. Warning
- II. Characteristics
- III. Technical Specifications
- IV. Clamp Meter Layout
- V. Button Functions
- VI. Operating Method
- VII. Measuring Principle
- VIII. Measuring Method for Grounding Resistance
- IX. Application in the Field
- X. Cautions for Measurement of Grounding Resistance
- XI. Maintenance
- XII. Battery Replacement



I. Warning

This product is designed and manufactured in conformity with the safety standards IEC61010-1 and IEC61010-2-032. This Instruction describes how to avoid accidents and damages to this product and how to maintain its sound conditions for a long time. Please read through this Instruction carefully before using the product.

Warning

- Please read through this Instruction carefully and have a complete understanding of it before using the apparatus.
- Please make sure to abide by the requirements of this Instruction whenever using the apparatus and to put this Instruction under safekeeping, so that you can refer to it whenever you need.
- Please strictly abide by the safety directions in this Instruction on the basis of understanding.
Please make sure to strictly abide by the aforesaid directions. Violation of the directions during operation may result in accidents and physical injury.

The mark  , on this apparatus means the necessity for reading through this Instruction for the sake of safety. This mark has three meanings as follows. Please read through the meanings carefully.

-  Danger To avoid serious or fatal damage that is possibly caused by a certain state or operation.
-  Warning To avoid the danger of electric shock.
-  Cautions To avoid damages to the apparatus and to ensure accurate measurement.

Danger

- Do not use it to measure a circuit of voltage to ground that is higher than AC300V.
- The jaw head is designed with a structure that can avoid short circuit of the Measured object, but please make sure to use the apparatus carefully when Testing uninsulated conductor, so as to avoid short circuit.
- Do not use this apparatus when your hands are wet.
- Make sure not to open the battery cover during test.

Warning

- Please stop using this apparatus if it is found to have a crack and the metal part is exposed during the operation.
- Do not dismantle or modify this apparatus or assemble substituted parts. If it needs repairing or adjustment, please send it to our company or retail store.
- Do not replace battery in wet conditions.
- When you need to open the battery cover to replace the battery, please shop Measuring first and then cut off the power.

Cautions

- Make sure that the functional button has been switched to the function required Before test.
- An entry beyond the test scope is not allowed during test.

- Do not place this apparatus in a high-temperature, humid or frosty place or a place exposed to direct sunlight.
- Make sure to cut off the power after finishing the operation. If the apparatus will be left unused for a long time, please take out the battery and put this apparatus under safekeeping.
- Do not use abrasive or organic solvent to clean the apparatus. Please wipe it with a cloth soaked in mild detergent or water.
- The jaw is precisely designed. Do not impose strong impact force on it, e.g. falling or violent percussion.
- Do not clamp other objects with the jaw head.
- Do not touch the jaw during test, or else the measured value would be inaccurate.

Here are several marks on the apparatus as follows. Please pay attention to the meaning when using the apparatus.

- ⚠ Users must refer to the Instruction when using this apparatus.
- ⚡ Application around and removal from HAZARDOUS LIVE conductors is permitted.
- ☐ The apparatus is designed with dual-insulating and reinforced-insulating protection.
- MC License for Measuring Instruments of the People's Republic of China

II. Characteristics

This series of clamp-shaped grounding resistance meters have made a significant breakthrough in the traditional measuring techniques for grounding resistance. They have been extensively applied in grounding resistance measurement of electric equipment used in the field of electric power, telecommunication, meteorology, oil field, building and industry.

When using this series of clamp-shaped grounding resistance meters to measure grounding systems with circuit, there is no need to cut off the ground down lead or use auxiliary electrode, thus being featured by safety, swiftness and easy operation.

This series of clamp-shaped grounding resistance meters can detect grounding failures which can not be detected by using traditional methods and can be used in some occasions to which the traditional methods are inapplicable, because what they measure is comprehensive value of the resistance of earth body and ground lead.

- This apparatus is designed and produced in strict conformity with the safety standards IEC61010-1 and IEC61010-2-032. It complies with the voltage standard CATIII 300V and the safety standard for pollution grade II.
- Measurement of grounding resistance
- 4-digit LCD display
- Automatic shutdown function
- Self-alignment after boot-strap

- Backlight function
- Data retention function
- Data save function
- Data access function

III. Technical Specifications

Range and Accuracy

Measuring Mode	Range	Resolution	Accuracy
Resistance	0.01Ω-0.099Ω	0.001 (Ω)	±(2%+0.02Ω)
	0.1Ω-0.99Ω	0.01 (Ω)	±(2%+0.02Ω)
	1.0Ω-49.9Ω	0.1 (Ω)	±(1.5%+0.1Ω)
	50.0Ω-99.5Ω	0.5 (Ω)	±(2%+0.5Ω)
	100Ω-199Ω	1 (Ω)	±(3%+1Ω)
	200Ω-395Ω	5 (Ω)	±(10%+5Ω)
	400Ω-590Ω	10 (Ω)	±(20%+10Ω)
Current	600Ω-1000Ω	20 (Ω)	±(25%+20Ω)
	0.0-100mA	0.1 mA	±(2.5%+2mA)
	100-300mA	1 mA	±(2.5%+2mA)
	0.30-2.99A	10 mA	±(2.5%+100mA)
	3.00-30.0A	100 mA	±(2.5%+100mA)



Range shift: Automatic
 0.01-1000Ω Range: 0.01-1000Ω
 0.001Ω Max resolution: 0.001Ω
 Power source: 6VDC (4 Size-AA alkaline dry batteries)
 Altitude: ≤2000m
 Working temperature: 0°C -40°C
 Relative humidity: 10%-90%
 LCD: 4-digit display
 Jaw dimension: 28 mm
 Dimension of clamp meter: 304× 104× 68 mm
 Weight (inc. battery): 1515.8 G
 Protection grade: Dual-insulating
 Structure feature: Jaw mode
 External magnetic field: <40A/m
 External electric field: <1V/m
 Single-time measuring duration: 1 sec.

Measuring frequency: > 1KHz

Attachment: Clamp-shaped grounding resistance meter.....	1pc
Test loop	2pcs
Size-AA alkaline dry battery	4pcs (LR4)
Apparatus cabinet.....	1pc
Instruction.....	1pc

IV. Clamp Meter Layout

1. Appearance Description

- (1) .Jaw: length: 65 × 30mm; diameter: Φ30mm
- (2) .Trigger: control jaw opening/closure
- (3) .Button area
- (4) .LCD area

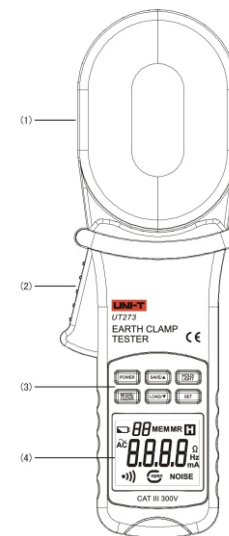

2. LCD

(1) .	Sign of low battery voltage
(2) .	2-digit LCD display of saved data
(3) .	Mark of saved data display
(4) .	Mark of accessed data display
(5) .	Sign of data hold
(6) .	Mark of resistance unit display
(7) .	Mark of frequency unit display
(8) .	Mark of current unit display
(9) .	Sign of noise indication
(10) .	Sign of jaw opening
(11) .	Sign of alarm display
(12) .	4-digit LCD display
(13) .	Sign of alternating current

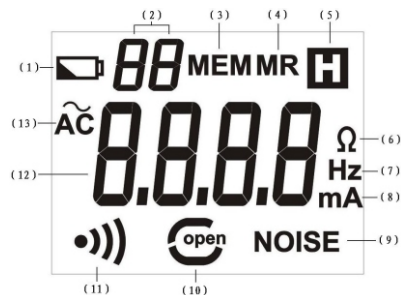

3. Description of Special Signs

- (1): Sign of jaw opening. This sign will be displayed when the jaw is open. It means manual withholding of trigger or serious pollution of jaw. Measurement with the clamp meter should be stopped under this circumstance.
- (2): Sign of low battery voltage. This sign will be displayed when the battery voltage is low. The accuracy of measurement can not be ensured under this circumstance. The battery should be replaced.
- (3): The sign "OLΩ" means that resistance of the measured object exceeds the upper limit of clamp meter.
- (4): The sign "LO.01Ω" means that resistance of the measured object exceeds the lower limit of clamp meter.

V. Button Functions

Press and hold it for 3 seconds for boot-strap; power the apparatus off by short press.

Shift to single-time save by short press; press and hold it for automatic save of fixed speed. When under Save Mode, quit from this mode by either long press or short press on Save. In single-time save, the sequence number will be displayed for 1 sec. You will quit from Save Mode automatically. The function of this button during the 1 sec. is the same as the function under [HOLD] mode.

Measurement is forbidden at this moment. The value and sequence number of save will be displayed. Note: 30 records being saved.

During resistance measurement, lock the current displayed value by short press on **HOLD** and the sign HOLD will be displayed. Cancel locking by short press on **HOLD** again and the sign HOLD will disappear. Measurement can be continued at this moment. Press and hold **HOLD**/**LIGHT** for opening/closure of backlight.

Press and hold **MODE/CLEAR** for clearance of saved data (complete clearance). Shift to single-time load by short press; press and hold it for automatic load of fixed speed. When under Load Mode, quit from this mode by either long press or short press on **LOAD/▼**.

Press this button to enter **SET** mode;

Under SET mode:

SAVE/▲ and **LOAD/▼** means increasing and decreasing function respectively. SAVE/LOAD is ineffective under this mode.

(short press for single-time increase/decrease; long press for accelerated increase/ accelerated decrease)

Several states of SET mode are as follows:

- 01: Setup of resistance limit and alarm value (default: 100Ω)
- 02: Setup of automatic shutdown time (5min, 10min, 15min, 20min and OFF; OFF means cancellation of automatic shutdown; default: 5min)
- 03: Clearance of designated saved data (Under this mode, press ▲/▼ to designate save place; press **CLEAR** again for clearance. In case of no saved data, “—” will be displayed on the meter.)
- 04: Setup of 0Ω relative measuring function (This function is mainly designed for users' elimination of error in contact resistance. It can eliminate 0.04Ω contact resistance. Users may calibrate the meter with supposed 0Ω resistance. During measurement, if the reading is lower than 0.04Ω, press the button **MODE** and **L<0.01Ω** will be displayed, or “ERR” will be displayed to indicate incorrect operation.
- 05: Setup of power save in backlight (two backlight grades: 0 and 1; luminance of Grade 0 is twice as much as that of Grade 1; default: 1)
- 06: Bios Setup Utility (default: 0; press ▲/▼ to shift to Grade 1 and bios setup utility will be realized; all the aforesaid functions will be relapsed to default state.)
- 07: Display of “END”

Setup of the aforesaid functions will remain effective after shutdown and reboot.

VI. Operating Method

1.Boot-trap

Before boot-trap, withhold the trigger for one or two times to ensure that jaw opening/closure is in sound condition.

Press and hold the button POWER for 3 sec. for boot-trap. LCD will be first tested automatically. All signs will be displayed (as shown in Fig. 1). Self-inspection will follow and “CAL0, CAL1, CAL2, CAL3.....CAL7, OL Ω ” will be displayed successively during self-inspection (as shown in Fig. 2). When “OL Ω ” appears, self-inspection has been finished and measurement of resistance has become allowable (as shown in Fig. 3).

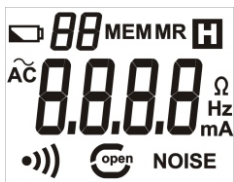

Fig.1 LCD display of all signs during self-inspection



Fig.2 During self-inspection



Fig.3

⚠ Cautions: Do not withhold the trigger, open the jaw, or clamp any lead during self-inspection. Make sure to maintain natural stationary state of clamp meter. Do not turn it over; do not impose external force on the jaw, or else the accuracy of measurement will not be ensured.

If conductor circuit is wound on the jaw during self-inspection, the measuring result will be inaccurate. Please remove the conductor circuit and reboot.

If a fairly high resistance value rather than OL appears after boot-trap and self-inspection (as shown in Fig.4), but a correct result is displayed when tested with a test loop, this indicates that considerable error happens in clamp meter when it is used to measure high resistance value (e.g. higher than 100 Ω), and the original accuracy remains unchanged when it is used to measure low resistance value. Please feel assured when using it.

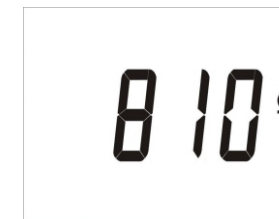

Fig.4

2. Measurement of Resistance

Measurement of resistance is available when the sign “OLΩ” appears after boot-trap and self-inspection. At this moment, you may withhold the trigger, open the jaw, clamp the circuit to be measured, and read the resistance value.

⚠ Cautions: Do not withhold the trigger, open the jaw, or clamp any lead during self-inspection. Make sure to maintain natural stationary state of clamp meter. Do not turn it over; do not impose external force on the jaw, or else the accuracy of measurement will not be ensured.

If necessary, you may test the clamp meter with a test loop (as shown in the following figure). The value displayed should be the same as the nominal value on the test loop (10Ω).

The nominal value on test loop is a value obtained at 20°C.

It is normal when the value displayed is different from the nominal value by one unit.

E.g. If the nominal value is 10Ω, the value displayed will be normal if it is 9.9Ω or 10.1Ω.

Display of “OLΩ” indicates that the measured resistance exceeds the upper limit of clamp meter (as shown in Fig.3)

Display of “L0.01Ω” indicates that the measured resistance exceeds the lower limit of clamp meter (as shown in Fig.5)

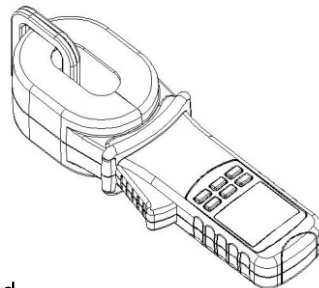

When under HOLD mode, press the button HOLD to quit from this mode and then measurement can be continued.

L0.01Ω

Fig.5

3. Measurement of Current

Measurement of current is available when the sign “OL Ω” appears after boot-strap and self-inspection. Press MODE/CLEAR for current measuring mode. At this moment, you may withhold the trigger, open the jaw, clamp the circuit to be measured, and read the resistance value.

⚠ Cautions: Do not withhold the trigger, open the jaw, or clamp any lead during self-inspection. Make sure to maintain natural stationary state of clamp meter. Do not turn it over; do not impose external force on the jaw, or else the accuracy of measurement will not be ensured.

⚠ Note: This function is only available in Ut275.

4. Shutdown

When clamp meter is on, press the button POWER to power it off.

When the time for automatic shutdown arrives, the LCD will twinkle for 30 seconds and clamp meter will be powered off automatically. Such function can reduce battery consumption.

VII. Measuring Method for Grounding Resistance

1. Multi-point Grounding System

Multi-point grounding system (e.g. tower grounding of power transmission system, grounding system of communication cable and some buildings, etc.) is constituted via the connection of aerial earth wire (screening layer of communication cable), as shown in the following diagram.

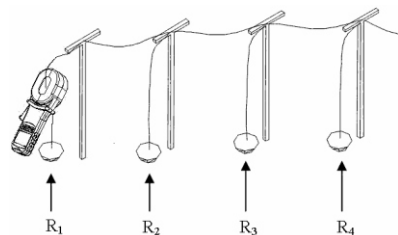

When measuring the multi-point grounding system with a clamp meter (as shown in the above diagram), the equivalent circuit is as shown in the following diagram.

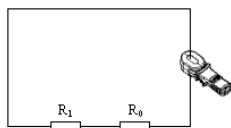

17

Of which R_1 stands for forecasted grounding resistance and R_0 stands for equivalent resistance of the paralleled-connected grounding resistance of other towers. From the perspective of strict grounding theory, due to the existence of so-called “mutual resistance”, R_0 is not the general parallel-connected value in the sense of electric engineering (it is slightly higher than the latter). However, as the grounding hemisphere of each tower is far smaller than the distance between towers, and the number of grounding points is huge, R_0 is far lower than R_1 . Accordingly, R_0 can be reasonably supposed to be zero from an engineering perspective. In this case, the resistance measured should be R_1 .

Multiple times of experiment in different environments and on different occasions in comparison with traditional methods has proved that the aforesaid hypothesis is completely reasonable.

2. Finite-point Grounding System

Such situations as follows are fairly common: 5 towers are connected to each other via aerial earth wire; grounding of some buildings is not a separate grounding network. Instead, several earth bodies are connected to each other via lead.

For the same reason, we neglect the effect of mutual resistance and calculate the equivalent resistance of parallel-connected grounding resistance by using the common method. In this case, N equations can be obtained for the grounding system of N (N is fairly small, but larger than 2) earth bodies.

18

$$R_2 + \frac{1}{\frac{1}{R_1} + \frac{1}{R_3} + \dots + \frac{1}{R_N}} = R_{2T}$$

$$R_N + \frac{1}{\frac{1}{R_1} + \frac{1}{R_2} + \dots + \frac{1}{R_{(N-1)}}} = R_{NT}$$

$$R_N + \frac{1}{\frac{1}{R_1} + \frac{1}{R_2} + \dots + \frac{1}{R_{(N-1)}}} = R_{NT}$$

Of which R_1, R_2, \dots, R_N is the grounding resistance of N earth bodies that we require. $R_{1T}, R_{2T}, \dots, R_{NT}$ is the resistance measured with clamp meter at every grounding branch.

This is a system of non-linear equations with N unknown numbers and N equations. It has a definite solution, but it's very difficult to find the solution manually, or even impossible when N is fairly large.

Accordingly, please select our company's calculating program software for finite-point grounding system. With this software, you can find the solution with a computer or notebook.

Theoretically speaking, this method generates no measuring error caused by negligence of R_0 except for the negligence of mutual resistance.

However, you need to note that you must measure the same number of tested

values for program calculation as the number of connected earth bodies in your grounding system. Larger or smaller number of such earth bodies will result in error. The program will generate the same number of grounding resistance values.

3. Single-point Grounding System

According to the testing theory, this series of clamp meters can be used to measure circuit resistance only, rather than single-point grounding resistance. However, you can definitely make a circuit by yourself with a test wire and the earth electrode nearby the grounding system, and then test it. We'll introduce two methods for measuring single-point grounding resistance with clamp meter. These methods are applicable to such objects that can not be tested by using the traditional voltage-current method.

(1). Two-point Method

As shown in the following diagram, find a separate earth body R_B in sound grounding conditions nearby the earth body R_A to be tested (e.g. nearby running water pipe or building, etc.). Connect R_A and R_B with a test wire.

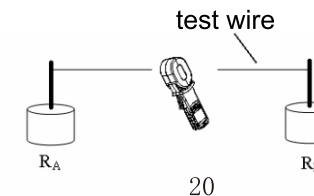

The resistance measured by clamp meter is the string value of two grounding resistances and the resistance of test wire.

$$R_{\text{meter}} + R_A + R_B + R_{\text{wier}}$$

Of which: R meter stands for the resistance measured by clamp meter; R wire stands for the resistance of test wire. Connect both ends of the test wire and you can measure its resistance by using clamp meter.

Accordingly, if the measuring value obtained by using clamp meter is smaller than the permissible value of grounding resistance, grounding resistance of these two earth bodies will be eligible.

(2).Three-point Method

As shown in the following diagram, find two separate wire bodies (RB and RC) nearby the earth body RA to be tested.

Step 1: Connect RA and RB with a test wire and read the first datum R1 via clamp meter.

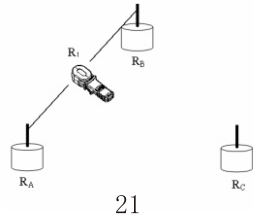

Step 2: Connect RB and RC (as shown in the following diagram) and read the second datum R2 via clamp meter.

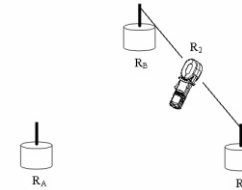

Step 3: Connect RC and RA (as shown in the following diagram) and read the third datum R3 via clamp meter.

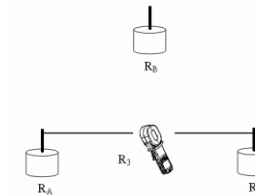

The reading measured by each step above is the string value of two grounding resistances. With the reading, it is very easy to calculate each grounding resistance value.

$$\text{Where: } R_1 = R_A + R_B$$

$$R_2 = R_B + R_C$$

$$R_3 = R_C + R_A$$

$$\text{So: } R_A = \frac{R_1 + R_3 - R_2}{2}$$

This is the grounding resistance value of earth body RA. To facilitate the memorization of this formula, we can regard the three earth electrodes as a triangle. In this case, the measured resistance is equal to the value obtained from the resistance at an adjacent side plus resistance at another adjacent side and minus the resistance at opposite side and then divide by 2.

Grounding resistance value of the other two earth bodies as reference:

$$R_B = R_1 - R_A$$

$$R_C = R_3 - R_A$$

VIII. Application in the Field

1. Application of Power System

- (1). Measurement of grounding resistance of power-transmission tower
The grounding of power-transmission tower generally constitutes a multi-point grounding system. Clamp a ground down lead with this series of clamp meter and you can measure the grounding resistance value of this branch.
- (2). Measurement of grounding resistance of transformer neutral point
There are two occasions in the grounding of transformer neutral point: a multi-point grounding system will be constituted in case of repeated grounding; in case of no repeated grounding, single-point grounding will be measured. When “L 0.01Ω” is displayed on clamp meter during measurement, it is possible that a tower or transformer has two or more ground down leads that are connected underground. In this case, we should retain only one ground down lead and untie the others.
- (3). Application in power plant and substation
This series of clamp meters can be used to test the contact and connection of circuit. With a test wire, we can measure the connection of devices in power plant and substation to the ground network. Grounding resistance can be measured as single-point grounding.

2. Application in Telecommunication System

- (1). Measurement of grounding resistance of machine rooms

Machine room for telecommunication system is usually arranged on an upper floor of a building. It is very difficult to measure the grounding resistance with a megger. Instead, it is very easy to measure it with this series of clamp meters. Use a test wire to connect fire hydrant to the earth electrode to be tested (machine room is always provided with fire hydrant), and then use clamp meter to measure the test wire.

Resistance value of clamp meter = grounding resistance of machine room + resistance value of test wire + grounding resistance of fire hydrant
If grounding resistance of the fire hydrant is very small,

Grounding resistance of machine room \approx resistance value of clamp meter - resistance value of test wire

(2). Measurement of grounding resistance of machine room and transmitting tower:

Grounding of machine room and transmitting tower usually constitutes a two-point grounding system (as shown in the following diagram):

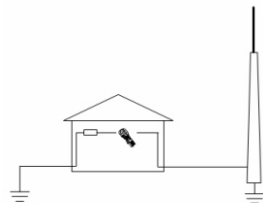

25

If the measuring value obtained by using clamp meter is smaller than the permissible value of grounding resistance, grounding resistance of the machine room and transmitting tower will be eligible. If the former is larger than the latter, please measure it as single-point grounding.

3. Application in Lightning Grounding System of Building

If earth electrodes of a building are separated from each other, grounding resistance of each earth electrode should be measured as follows:

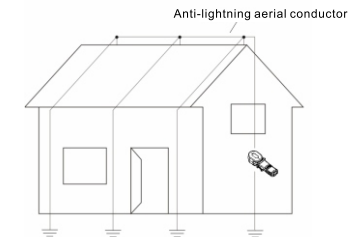

4. Application in Grounding System of Gas Station

Anti-explosion products must be used in environment with explosive gas such as gas station, oil field and oil groove.

According to the Testing Specifications for Grounding Anti-static Devices (JJF2-2003), grounding resistance and connecting resistance of the following facilities in gas station need to be tested. The clamp meter used in such test must comply with

26

the requirements of Electric Equipment Applicable to Environment with Explosive Gas (GB3836-2000).

No .	Items Tested	Technical Requirements
1	Grounding resistance of oil tank	$\leq 10 \Omega$
2	Grounding resistance of loading/unloading point	$\leq 10 \Omega$
3	Grounding resistance of oiling machine	$\leq 4 \Omega$
4	Connecting resistance of filling hose on oiling machine	$\leq 5 \Omega$

(1).Measurement of grounding resistance of oil tank and loading/unloading point:

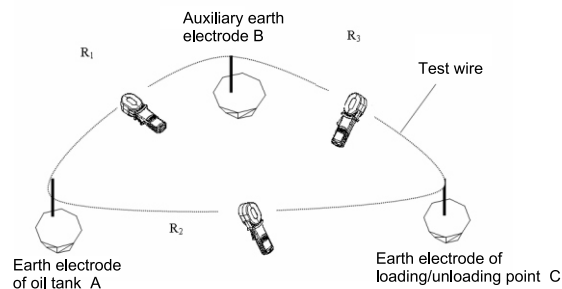

In the grounding system of gas station, earth electrode of oil tank A is connected to oiling machine. Earth electrode of loading/unloading point C is a separate earth electrode. Find another separate earth electrode as auxiliary earth electrode B (e.g. running water pipe), and use clamp meter to measure value R1, R2 and R3 by using three-point method.

Earth electrode of oil tank can be calculated as follows:

$$R_A = \frac{R_1 + R_2 - R_3}{2}$$

Grounding resistance of auxiliary earth electrode

$$R_C = R_2 - R_A$$

Grounding resistance of loading/unloading point

$$R_B = R_1 - R_A$$

Note: BC and AC should not be connected with lead when measuring R1; the same with the measurement of R2 and R3.

(2).Measurement of grounding resistance of oiling machine

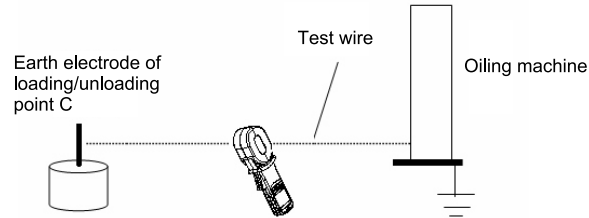

Find an earth electrode which is separate from the earth electrode of oiling machine, e.g. earth electrode of loading/unloading point. Use a test wire to connect two electrodes together, and then obtain a reading R meter via a clamp meter. Grounding resistance of oiling machine can be calculated as follows:

Grounding resistance of oiling machine: $R_{\text{machine}} = R_{\text{meter}} - R_c$

Of which: R_{mete} stands for the resistance value measured by clamp meter; R_c stands for grounding resistance of the loading/unloading point.

(3).Measurement of connecting resistance of filling hose on oiling machine

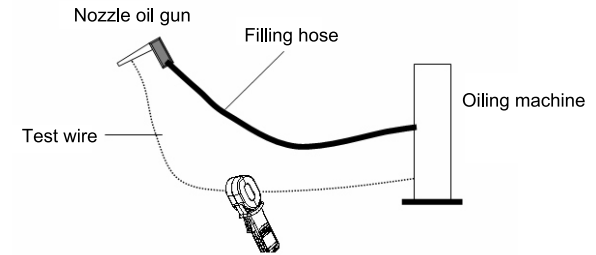

Use a test wire to connect nozzle oil gun and oiling machine together, and then obtain a reading R meter via a clamp meter. Connecting resistance of filling hose on oiling machine can be calculated as follows:

Connecting resistance of filling hose on oiling machine: $R_{\text{hose}} = R_{\text{mete}} - R_{\text{wire}}$

Of which: R_{mete} stands for the resistance value measured by clamp meter; R_{wire} stands for the resistance of test wire.

IX. Measuring Theory

The fundamental theory for the measurement of grounding resistance by using this series of clamp-shaped grounding resistance meter is actually the measurement of circuit resistance. As shown in the following diagram, the jaw of clamp meter is composed of voltage loop and current loop. Voltage loop can provide incentive signal

and induce an electric potential E in the tested circuit. Current I will generate in the tested circuit under the effect of electric potential E. Use clamp meter to measure E and I and the measured resistance R can be calculated via the following formula:

$$R = \frac{E}{I}$$

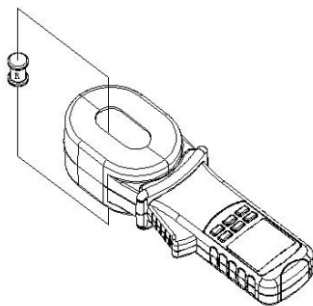

X. Cautions for Measurement of Grounding Resistance

- Users may conduct comparative test with our clamp meter and by using traditional voltage/current method. The results may be considerably different. Please pay attention to the following issues:
 - Whether the buckle is unfastened when conducting test with traditional voltage/current method (i.e. whether the earth body to be tested is separated from the grounding system); if the buckle is unfastened, the measured grounding resistance value should be the parallel-connected value of the grounding resistance of all earth bodies.

It may be insignificant to measure the parallel-connected value of the grounding resistance of all earth bodies, because the purpose of our measurement of grounding resistance is to compare it with a permissible value provided in relevant standard, so as to judge whether the grounding resistance is eligible. However, we have not found a national standard in a certain industry that has provisions on the whole grounding system, rather than a single grounding branch.

For example: The permissible value of grounding resistance that is specified in Code for Design of “66kV or under Over-head Electrical Power Transmission Line (GB50061-97) is targeted at the so-called “Each Tower” . It is expressly pointed out in standard clause interpretation: Grounding resistance of each tower refers to the resistance value that is measured after earth body is disconnected from ground wire. If earth body is not disconnected from ground wire, the measured grounding resistance will be the parallel-connected grounding resistance of multiple towers” .

The aforesaid provisions are definite.

As mentioned above, the result obtained from the measurement with this series of clamp meters is the grounding resistance of each branch. It refers to grounding resistance of a single earth body on the condition that the ground wire is soundly connected.

Obviously, the results of measurement with this series of clamp meters and those by using traditional voltage/current method are incomparable at all. Since the objects are different, the evident difference in measuring results is normal.

(2).The grounding resistance value measured by using this series of clamp meters is comprehensive resistance of the earth branch, including contact resistance between such branch and the public ground wire as well as resistance of lead and earth body. By contrast, the value measured by using traditional voltage/current method after the buckle is unfastened is merely the resistance of earth body.

It is apparent that the former value is higher than the latter one. Such differential reflects the value of contact resistance between this branch and the public ground wire.

Please note that the grounding resistance provided in national standard includes the resistance of ground lead. It is provided in the terms and definitions of “Grounding of AC Electric Device” (DL/T621-1997): “the sum of resistance to earth of earth electrode or natural earth electrode and ground wire resistance is called Grounding Resistance of Grounding Device” .

Such provisions are definite as well, because resistance of lead wire and grounding resistance of earth body are equivalent from the perspective of anti-lightening.

It is for this reason that the following provisions are specified in various industrial standards: (ground down lead) “requires reliable electric connection” . However, such standards have not specified how to test the reliability. The reason is clear to us: the traditional voltage/current method is ineffective to such test.

By contrast, this series of clamp meters can provide such measuring data.

2 . Selection of measuring point

Before measuring certain grounding system (as shown in the following diagram), we should select a correct measuring point, or else different measuring results will be obtained.

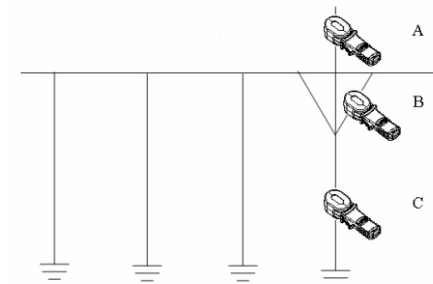

When measuring at Point A, the tested branch has not formed a circuit, and “OLΩ” will be displayed on clamp meter. In this case, such measuring point should be replaced. When measuring at Point B, the tested branch is a circuit formed by a metal conductor. “L 0.01Ω” or resistance value of the metal circuit will be displayed on clamp meter. In this case, such measuring point should be replaced. When measuring at Point C, what is tested is the grounding resistance value of the branch.

XI. Maintenance

Leaning of casing:

Wipe the surface with a soft cloth or sponge dipped in clean water

To avoid damage to the apparatus, do not immerse it in water.

When the apparatus is wet, please dry it before putting it aside.

If the apparatus needs calibration or repairing, please deliver it to professional repairing personnel with qualifications or the designated repair department.

XII. Battery Replacement

⚠ Danger

To avoid possible electric shock, please shut down the apparatus before replacing the battery.

⚠ Cautions

* Do not use new and used batteries together.

* Pay attention to the polarity of battery when mounting it.

⚠ Danger

* Do not use the apparatus to measure objects when the battery box is open.

* If the sign “” appears on LCD, it means that the battery needs to be replaced.

Please replace it by following these steps:

- (1) Press power to power off the apparatus.
- (2) Unscrew and remove battery cap from battery holder; replace 4 “AA” batteries.
- (3) Screw battery cap back to battery holder.

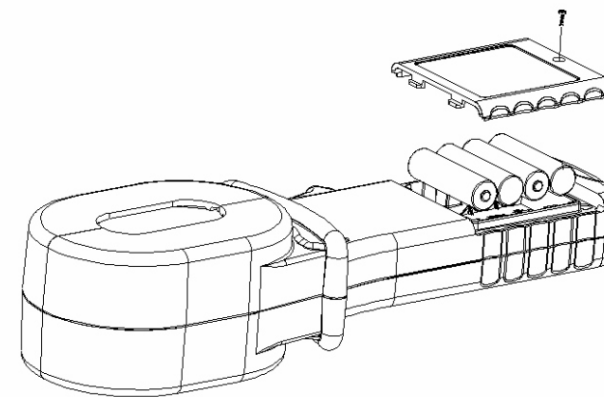

UNI-T®

UT270 OPERATING MANUAL

The Instruction is subject to change without further notice.

37

UNI-T®

UT270 OPERATING MANUAL



UNI-T®

UNI-TREND TECHNOLOGY (CHINA) CO., LTD.

No6, Gong Ye Bei 1st Road,
Songshan Lake National High-Tech Industrial
Development Zone, Dongguan City,
Guangdong Province, China
Tel: (86-769) 8572 3888
<http://www.uni-trend.com>

38

说明书菲林做货要求:

序号	项目	内容	
1	尺寸	150*118±1MM	
2	材质	封面\封底用128g铜板纸,内页用60g书纸做货	
3	颜色	黑字	
4	外观要求	印刷完整清晰、版面整洁,无斑墨、残损、毛边、刀线错位等缺陷。	
5	装订方式	两枚小钉钉装	
6	表面处理	无	
7	其它	/	
版本		REV.5 修改成股份有限公司,并修改第5页指标	
DWH 设计	陈萍2018.08.09	MODEL 机型: UT270系列	Part NO. 物料编号: 110401104567X
CHK 审核		 优利德科技(中国)股份有限公司 <small>UNI-TREND TECHNOLOGY (CHINA) CO., LTD.</small>	
APPRO. 批准	