

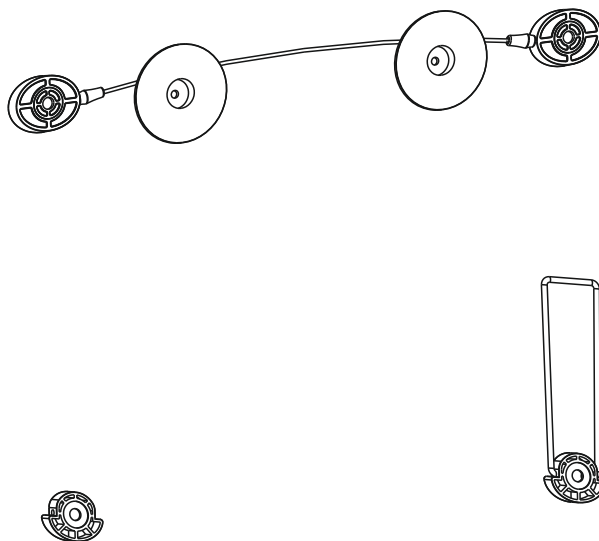

# UCH0112

## Fixed wall mount



## User manual



200x200/300x300  
400x200/400x400



50kg  
(110lbs)  
MAX

English 1-8

Polski 9-16

Română 17-24

Deutsch 25-32



**NOTE:** Read entire instruction sheet before you start installation and assembly.

## WARNING

- Do not begin to installation of the product on you have read and understand the instructions and warnings contained in this Installation Sheet. If you have any question regarding any of the instruction or warning, Please contact your local distributor.
- This product should only be installed by someone of good mechanical aptitude, with experience and basic building, and fully understands.
- Make sure that the supporting surface will safely support the combined load of the equipment and all attached hardware and components.
- Never exceed the Maximum Load Capacity.
- Always use an assistant or mechanical lifting equipment to safely lift and position equipment.
- Tighten screws firmly, but do not over tighten. Over tightening can damage the items, greatly reducing their holding power.
- This products intended for indoor use only. Use of this product outdoors could lead to product failure and personal injury.

*Specifications are subject to change without notice.*

### English



#### **Correct Disposal of This Product**

**(Applicable in the European Union and other European countries with separate collection systems)**

This marking shown on the product or its literature, indicates that It should not be disposed with other household wastes at the end of its working life. To prevent possible harm to the environment or human health from uncontrolled waste disposal, please separate this from other types of wastes and recycle it responsibly to promote the sustainable reuse of material resources.

Household users should contact either the retailer where they purchased this product, or their local government office, for details of where and how they can take this item for environmentally safe recycling.

Business users should contact their supplier and check the terms and conditions of the purchase contract This product should not be mixed with other commercial wastes for disposal



Made in China for LECHPOL Zbigniew Leszek, Miętne, 1 Garwolińska Street 08-400 Garwolin.

## Component checklist

**IMPORTANT:** Ensure you have received all parts against the component checklist prior to installing. If any parts are missing or faulty, telephone the special franchiser for a placement.



wall plate (x2)  
A

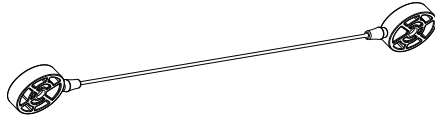

adapter bracket (x1)  
B



supporting spacer (x1)  
C

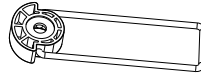

supporting spacer (x1)  
D

### Package M



M5x14 (x4)  
M-A

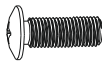

M6x14 (x4)  
M-B

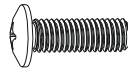

M8x20 (x4)  
M-C



M6x30 (x4)  
M-D



M8x30 (x4)  
M-E



D5 washer(x4)  
M-F



D8 washer(x4)  
M-G



small spacer (x8)  
M-H



big spacer (x4)  
M-I

### Package W



ST5.5x50 (x2)  
W-A



concrete anchor (x2)  
W-B



D6 washer (x2)  
W-C

# 1. Mount on Solid Brick and Concrete Block

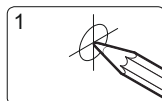
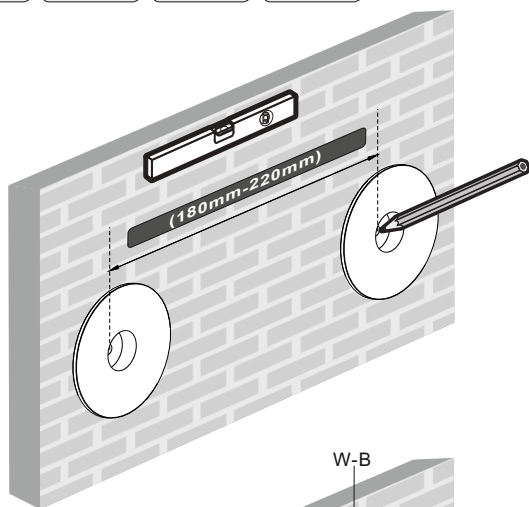
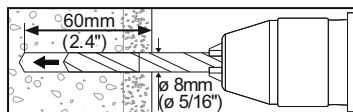
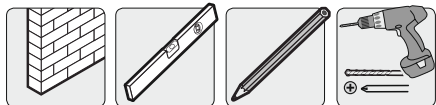

1  
Mark the exact location of mounting holes

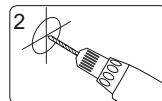

2  
Drill pilot holes

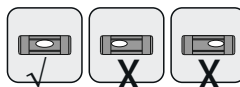
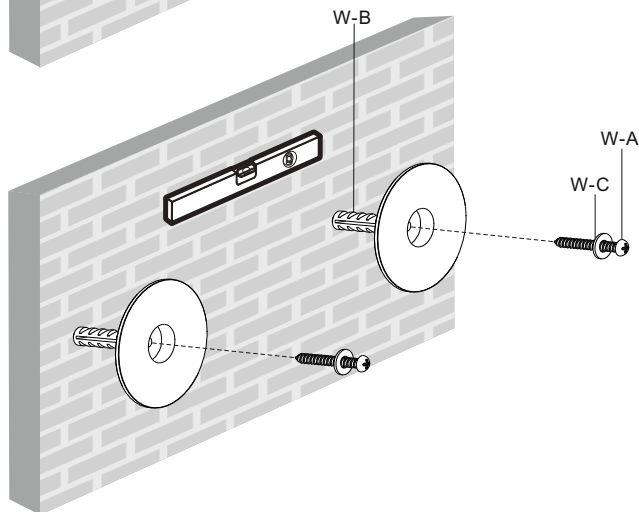

## WARNING

• Installers must verify that the supporting surface will safely support the combined load of the equipment and all attached hardware and components.

## 2. Install Adapter Brackets

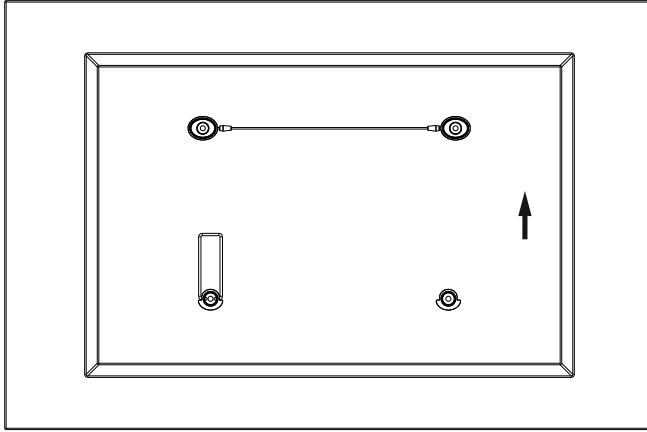

### 2-1 For Flat Back Screen

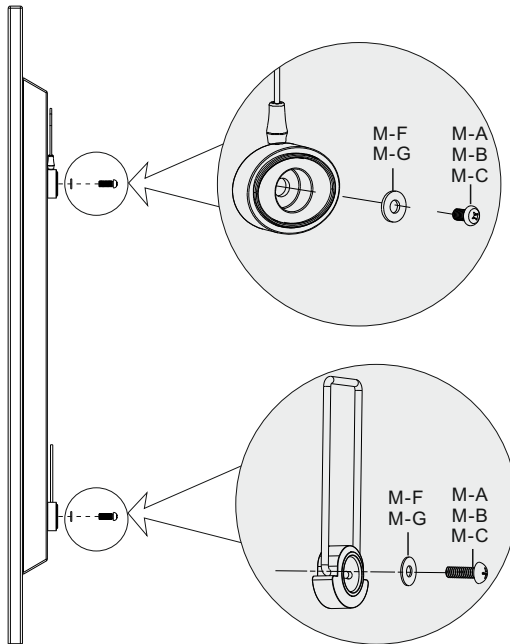
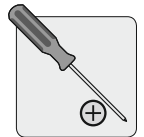

2-2 For Bump-out or Recessed Back Screens

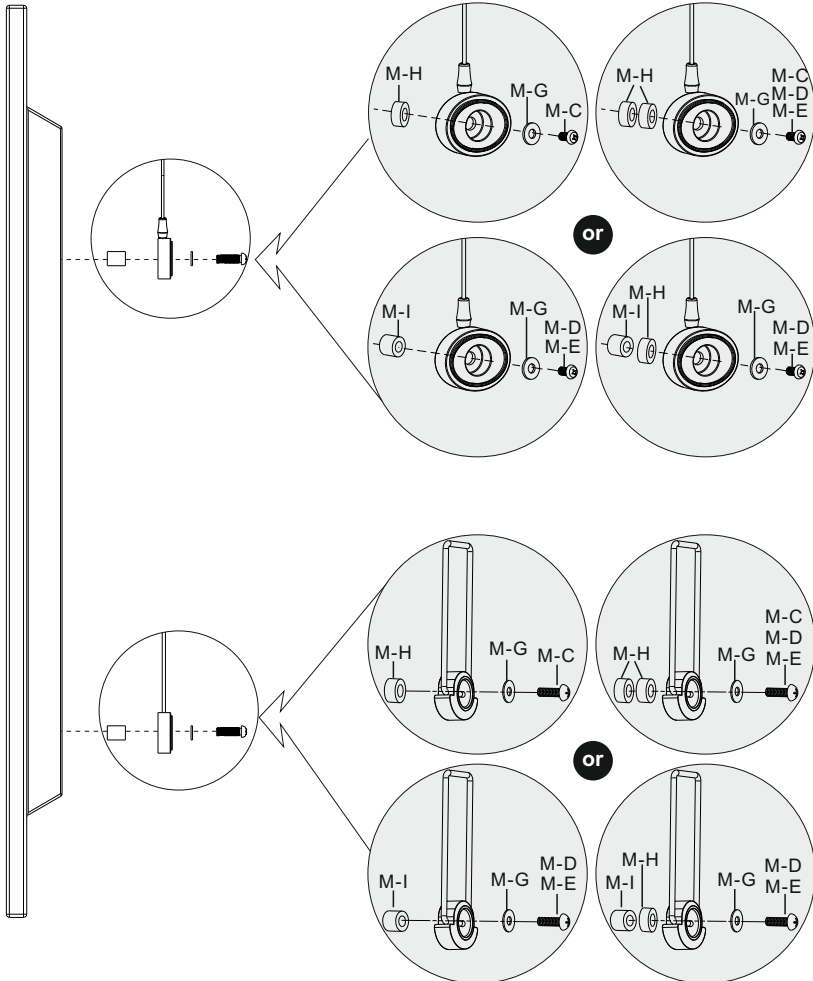

**Note:** Choose the appropriate screws, washers and spacers (if necessary) according to the type of screen.

- Screw the supporting spacers onto the TV.

 **Tighten all screws but do not over tighten.**

### 3. Hanging the TV onto the Wall Plate

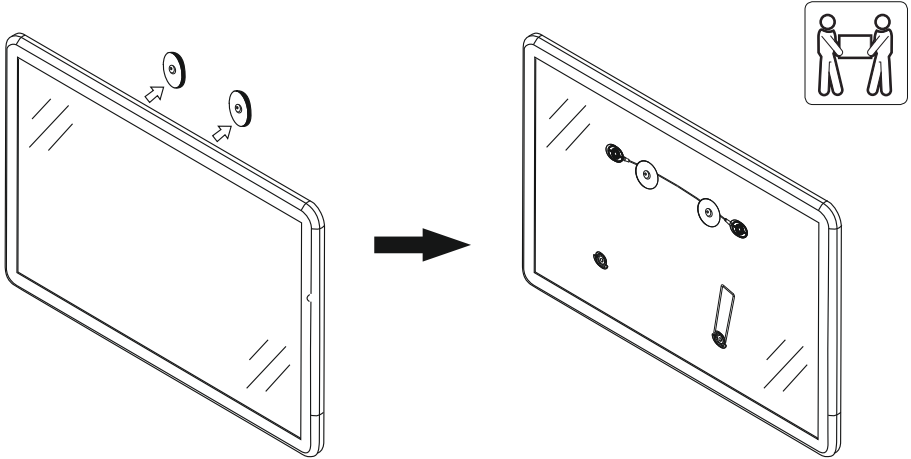

After the wall mount has been safely secured to the wall, Carefully lift your TV and hook wirerope into the wall plate rail. Make sure your TV is securely and correctly attached.

### 4. Cable Management

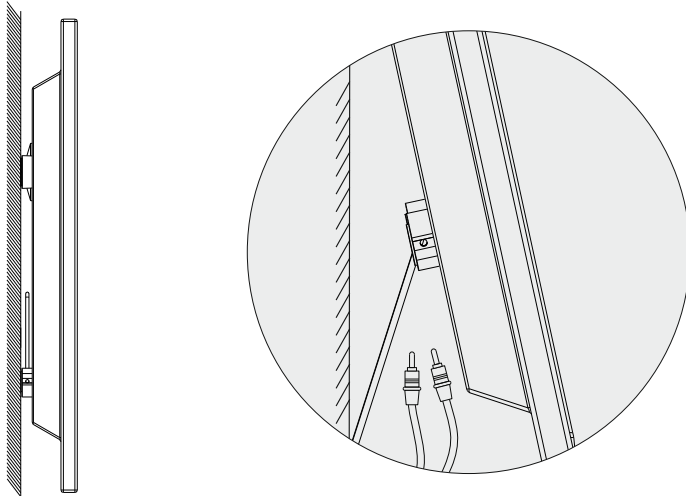

- Fold out the tilt supports to access the cables.
- Fold the tilt supports back once all cables have been installed.

### Maintenance

#### Maintenance

- Check that the bracket is secure and safe to use at regular intervals(at least every three months).
- Please contact your dealer if you have any questions.





# UCH0112

## Uchwyt ścienny do TV



## Instrukcja obsługi



200x200/300x300  
400x200/400x400



50kg  
(110lbs)  
MAX

English 1-8

Polski 9-16

Română 17-24

Deutsch 25-32

**UWAGA: Przed rozpoczęciem montażu, należy przeczytać instrukcję obsługi.**

## **UWAGA**

- Przed przystąpieniem do montażu, należy dokładnie przeczytać całą instrukcję obsługi. W przypadku jakichkolwiek wątpliwości, należy skontaktować się z lokalnym dystrybutorem.
- Należy przestrzegać zaleceń producenta odnośnie miejsca i sposobu montażu.
- Instalacja uchwytu powinna być przeprowadzona przez wykwalifikowaną osobę cechującą się dobrymi umiejętnościami mechanicznymi, znającą konstrukcję budynku oraz dobrze rozumiejącą instrukcję obsługi.
- Nie należy przekraczać dopuszczalnego maksymalnego obciążenia.
- Podczas przymocowywania telewizora, należy skorzystać z pomocy drugiej osoby.
- Śruby należy dokręcić mocno, lecz nie za mocno. Zbyt mocne dokręcenie może doprowadzić do zniszczenia lub osłabienia gwintu.
- Produkt przeznaczony jest do użytku wewnątrz pomieszczeń.

## Zawartość opakowania

**WAŻNE:** Należy się upewnić, że w zestawie są wszystkie elementy wymienione na liście. Jeżeli brakuje jakiegokolwiek części lub jest ona uszkodzona, należy skontaktować się z dystrybutorem.



uchwyt ścienny (x2)  
A

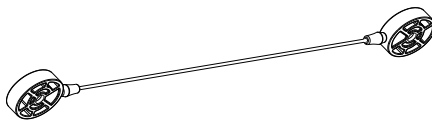

wspornik (x1)  
B



dystans (x1)  
C

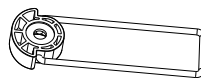

regulowany dystans (x1)  
D

## Opakowanie M



M5x14 (x4)  
M-A

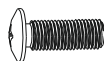

M6x14 (x4)  
M-B

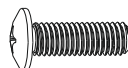

M8x20 (x4)  
M-C



M6x30 (x4)  
M-D



M8x30 (x4)  
M-E



D5 podkładka (x4)  
M-F



D8 podkładka (x4)  
M-G



dystans - mały (x8)  
M-H



dystans - duży (x4)  
M-I

## Opakowanie W



Śruba ST5.5x50 (x2)  
W-A

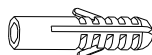

kołek rozporowy (x2)  
W-B



D6 podkładka (x2)  
W-C

## 1. Montaż do ściany betonowej

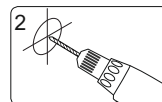
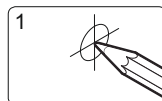
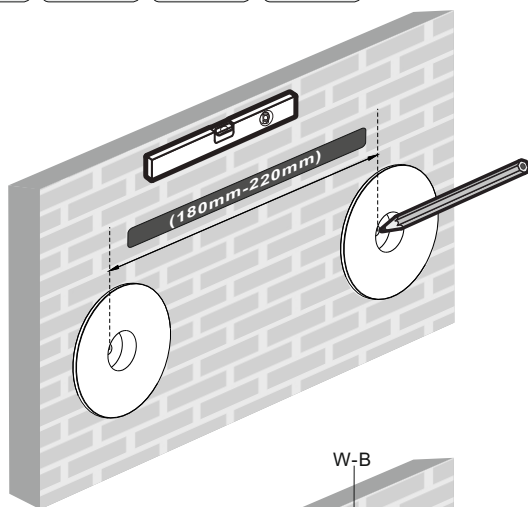
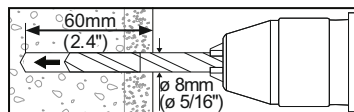
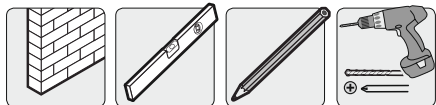

Należy dokładnie zaznaczyć i wywiercić otwory montażowe.

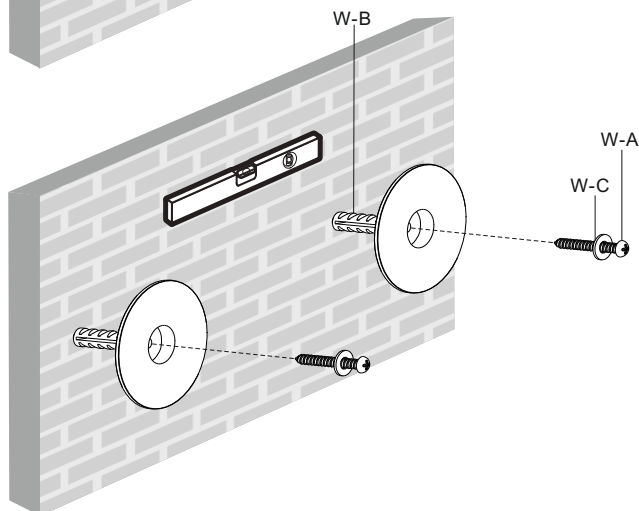
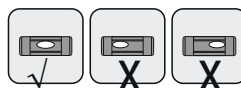

### ! UWAGA

- Należy się upewnić, że powierzchnia nośna wytrzyma obciążenie uchwyty wraz z podłączonymi do niego urządzeniami.

## 2. Montaż wsporników

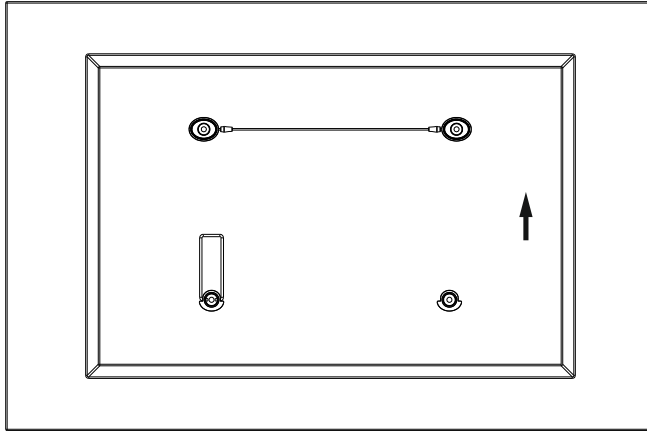

### 2-1 Telewizor z płaskim tyłem

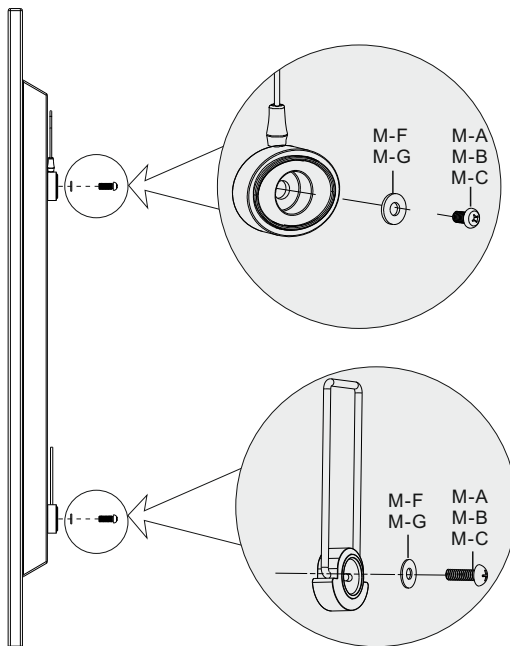
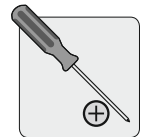
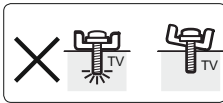

## 2-2 Telewizor z wypukłym tyłem

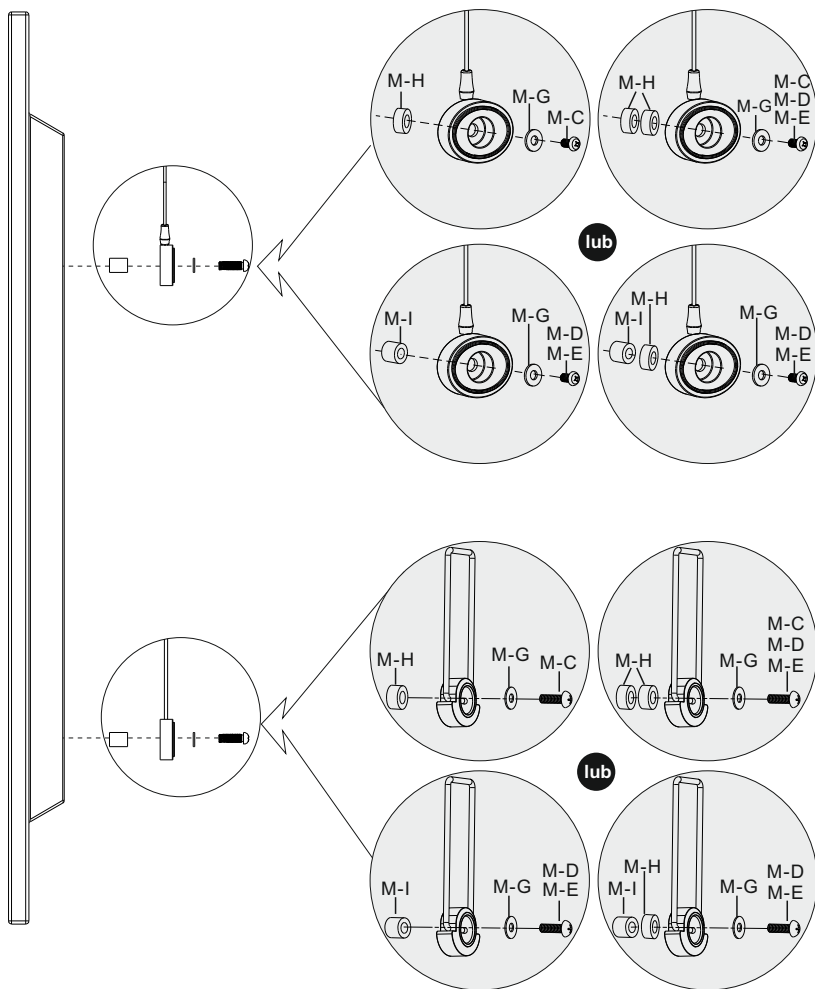
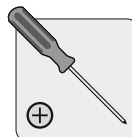

**Uwaga:** W zależności od typu ekranu należy użyć odpowiednich dystansów, podkładek i śrub.  
 • Za pomocą odpowiednich śrub należy przykręcić wsporniki do ekranu.



Śruby należy przykręcić mocno, ale nie zbyt mocno (aby nie zniszczyć gwintu).

### 3. Przymocowanie telewizora do uchwyty

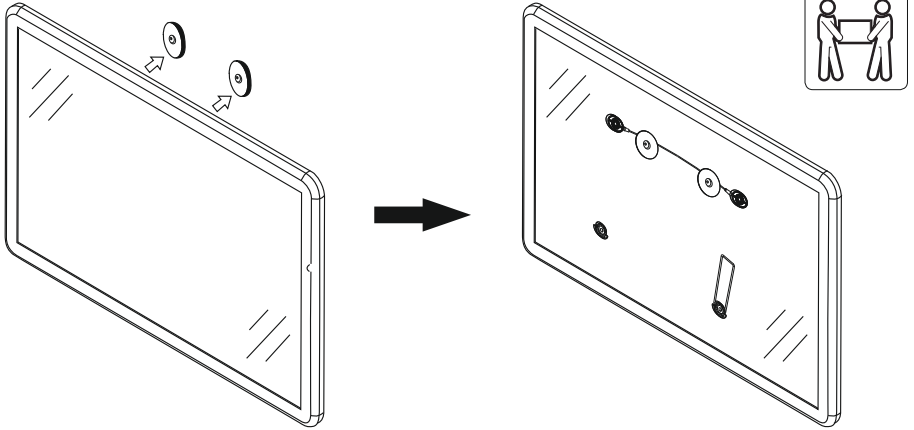

Telewizor wraz z przymocowanym wspornikiem należy zawiesić na uchwyty ściennym.  
**Uwaga:** Przed puszczeniem telewizora, należy się upewnić, że jest od dobrze zamocowany.

### 4. Podłączenie przewodów

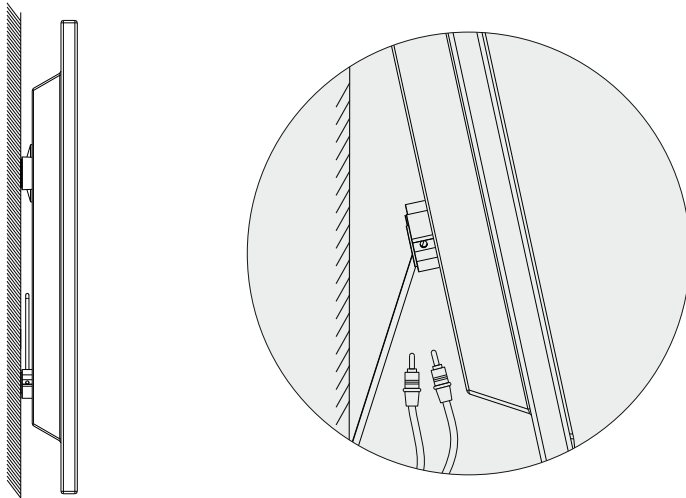

- Używając regulowanego dystansu, należy odchylić telewizor od ściany.
- Po podłączeniu przewodów, należy ustawić telewizor w pierwotnym położeniu.

## Użytkowanie

- Po zawieszeniu telewizora, należy się upewnić że jest on dobrze przymocowany. Należy okresowo (np. co kilka miesięcy) sprawdzać, czy śruby i inne elementy nie poluzowały się i są solidnie zamocowane.
- Jeżeli istnieją jakiegokolwiek wątpliwości lub problemy odnośnie montażu, należy skontaktować się z lokalnym dystrybutorem.

*Specyfikacja produktu może ulec zmianie bez powiadomienia.*

**Poland**



### ***Prawidłowe usuwanie produktu (zużyty sprzęt elektryczny i elektroniczny)***

Oznaczenie umieszczone na produkcie lub w odnoszących się do niego tekstach wskazuje, że po upływie okresu użytkowania, nie należy usuwać go z innymi odpadami pochodzącymi z gospodarstw domowych. Aby uniknąć szkodliwego wpływu na środowisko naturalne i zdrowie ludzi wskutek niekontrolowanego usuwania odpadów, prosimy o oddzielenie produktu od innego typu odpadów oraz odpowiedzialny recykling w celu promowania ponownego użycia zasobów materialnych jako stałej praktyki.

W celu uzyskania informacji na temat miejsca i sposobu bezpiecznego dla środowiska recyklingu tego produktu użytkownicy w gospodarstwach domowych powinni skontaktować się z punktem sprzedaży detalicznej, w którym dokonali zakupu produktu, lub z organem władz lokalnych.

Użytkownicy w firmach powinni skontaktować się ze swoim dostawcą i sprawdzić warunki umowy zakupu. Produktu nie należy usuwać razem z innymi odpadami komunalnymi.



Wyprodukowano w CHRL dla LECHPOL Zbigniew Leszek, Miętne ul. Garwolińska 1, 08-400 Garwolin.





# UCH0112

## Suport TV LCD LED

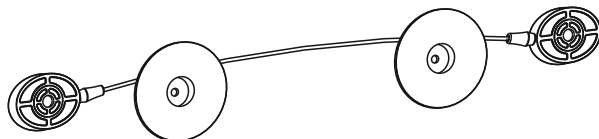

## Manual de utilizare



200x200/300x300  
400x200/400x400



50kg  
(110lbs)  
MAX

English 1-8

Polski 9-16

Română 17-24

Deutsch 25-32

## Inainte de instalare



- Nu incepeti instalarea suportului decat dupa ce ati citit si inteles instructiunile de montare.
- Respectati recomandarile din acest manual de instalare cu privire la distanta fata de perete necesara la montarea suportului.
- Instalarea suportului este recomandata sa fie executata de catre personal calificat.
- Verificati daca peretele este poate suporta sarcinile maxime admisibile de catre suport.
- Nu depasiti sarcina maxima admisibila a suportului.
- Asigurati-va ca suruburile de fixare pentru diblu sa fie centrate exact in mijlocul gaurilor de pozitionare de pe suport (eventual utilizati un dispozitiv de centrare) in momentul strangerii acestora.
- Strangeti suruburile ferm dar nu exagerati. Strangerea prea puternica a acestora poate distruge partile componente ale suportului
- Solicitati ajutorul altei persoane pentru pozitionarea aparatului pe suport.
- Suportul este destinat utilizarii in interior. Nu utilizati suportul in exterior pentru a evita riscul producerii de accidente sau defectarea produsului.

## Continut colet

Asigurati-va ca ati primit toate componentele necesare montarii suportului inainte de instalarea acestuia, urmarind figurile urmatoare:



placa de baza (x2)  
A

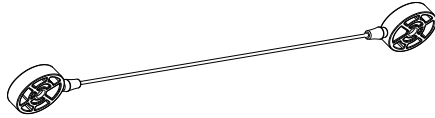

adaptor (x1)  
B



saiba (x1)  
C

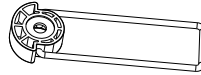

saiba (x1)  
D

## Pachet M



M5x14 (x4)  
M-A

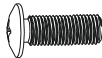

M6x14 (x4)  
M-B

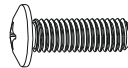

M8x20 (x4)  
M-C



M6x30 (x4)  
M-D



M8x30 (x4)  
M-E



D5 saiba (x4)  
M-F



D8 saiba(x4)  
M-G



Saiba mica (x8)  
M-H



Saiba mare (x4)  
M-I

## Pachet W



Surub ancorare ST5.5x50 (x2)  
W-A



diblu beton (x2)  
W-B



D6 saiba (x2)  
W-C

## 1. Montarea suportului pe perete de beton

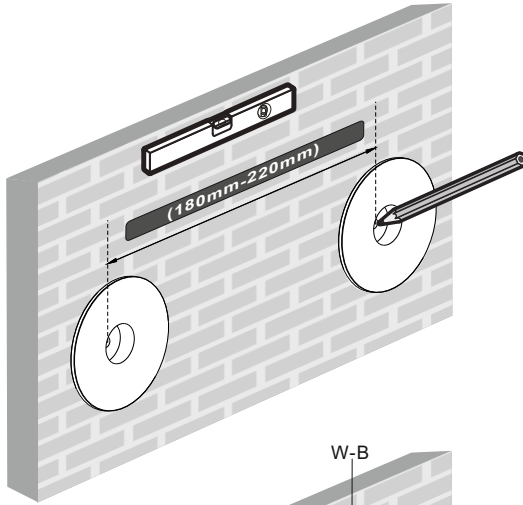
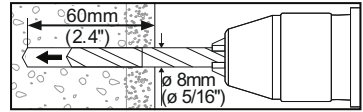
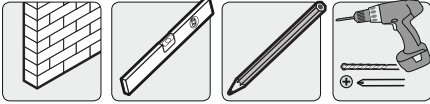

1  
**Marcați locația exactă a orificiilor de montare**

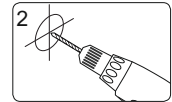

2  
**Efectuați gaurile de ghidare**

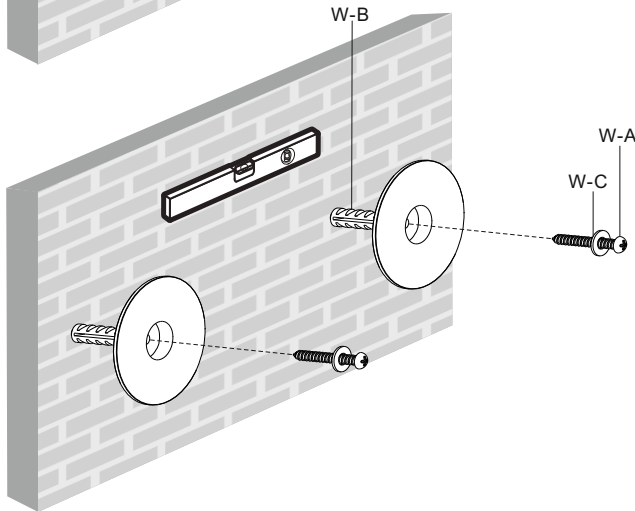
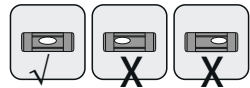

## AVERTISMENT

- Instalatorii trebuie să verifice dacă suprafața de sprijin va suporta în condiții de siguranță sarcina echipamentelor și toate componentele atașate.

## 2. Instalarea adaptoarelor pentru suport

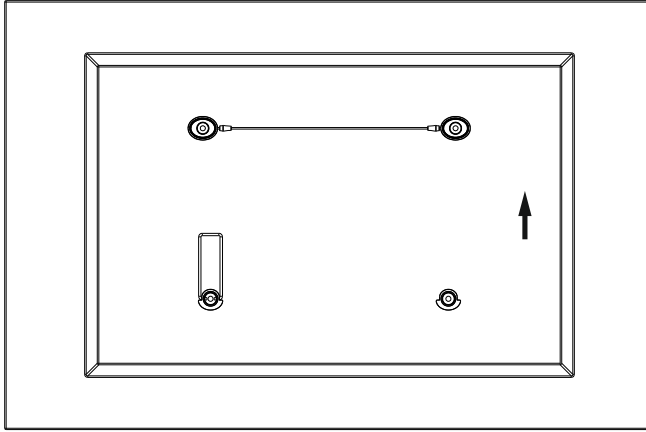

### 2-1 Pentru TV cu spatele drept (plat)

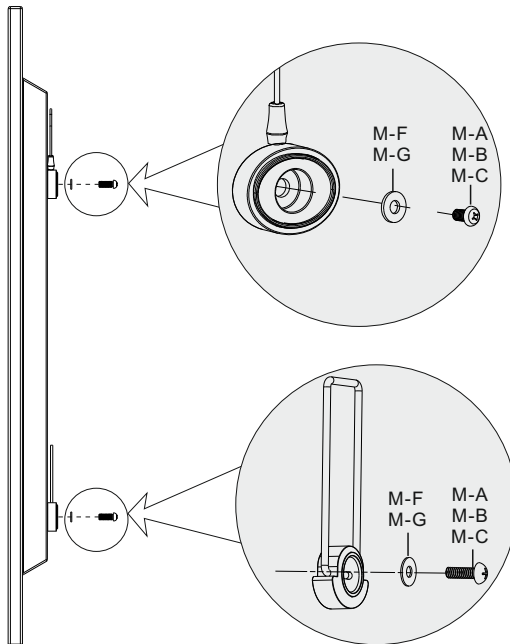

2-2 Pentru TV cu spatele curbat sau pentru accesarea intrarilor A/V

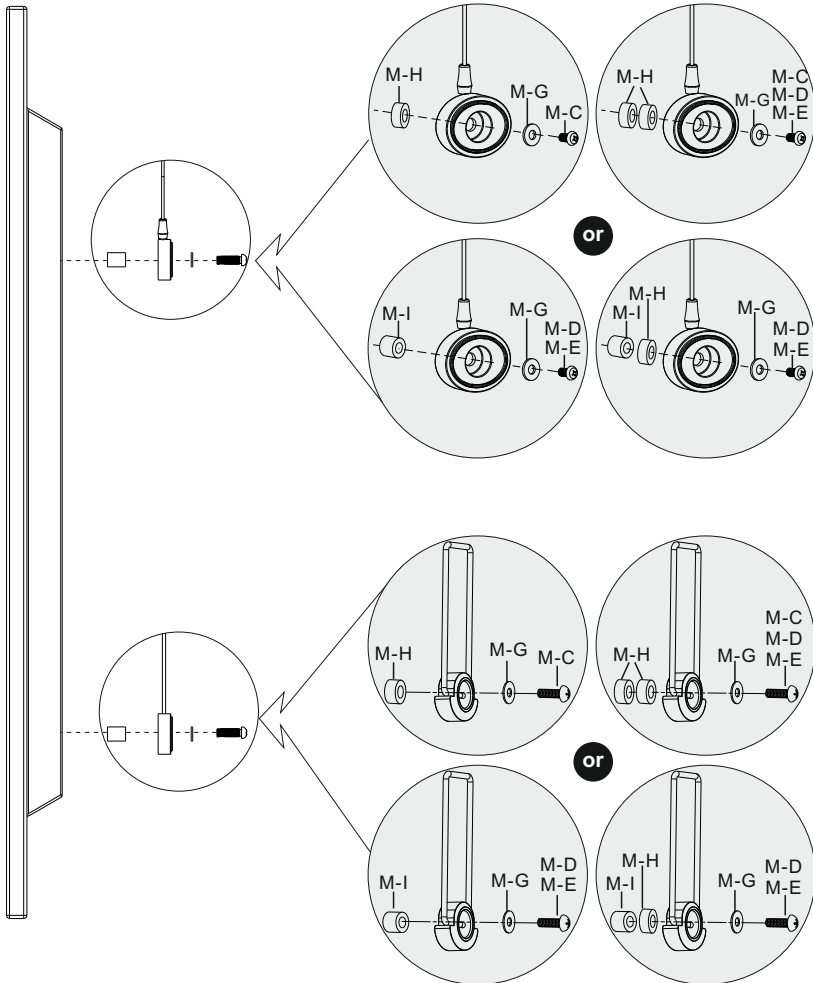
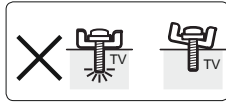
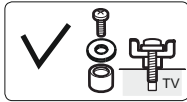

**Nota:** Alegeți suruburile, saibele și distanțierele (daca e necesar) în funcție de tipul ecranului.  
 • Înșurubați adaptoarele pe TV.

 **Strangeti toate suruburile dar nu exagerati.**

### 3. Montarea televizorului pe placa de perete

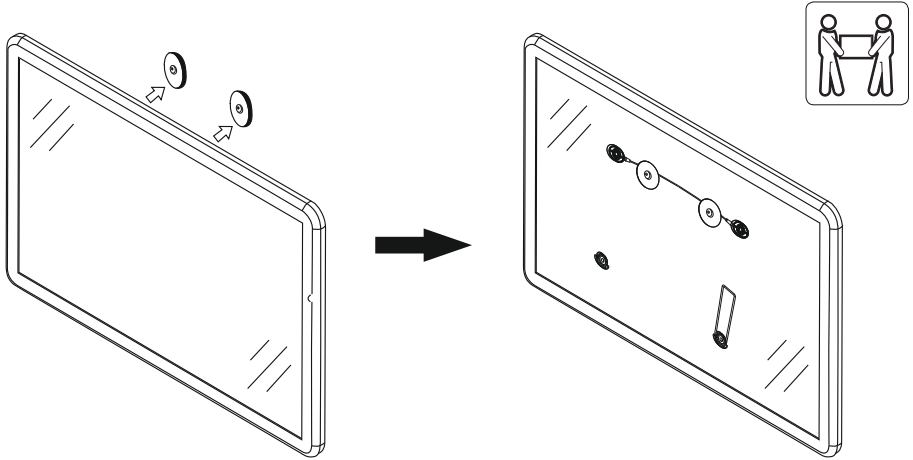

Dupa ce suportul de perete a fost fixat, ridicati cu grija televizorul si agatati sforile dispozitivului pe sina placii de perete. Asigurati-va ca televizorul este fixat in mod corespunzator.

### 4. Management cabluri

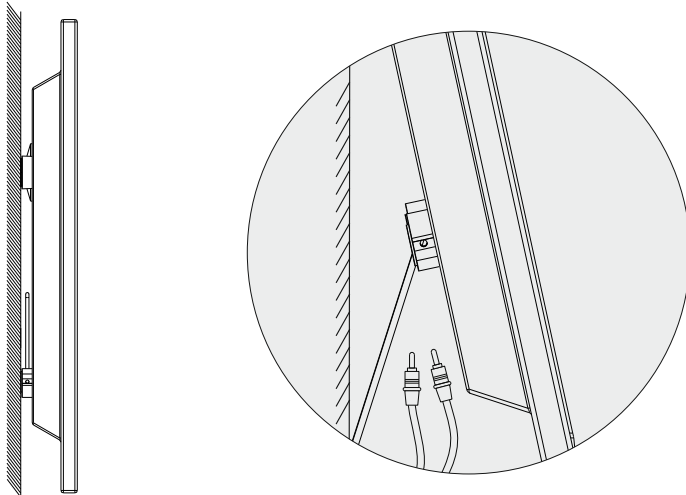

- Strangeti suportii de inclinare pentru a accesa cablurile.
- Strangeti suportii inapoi odata au fost instalate toate cablurile.

## Intretinere

### Intretinere

- Verificati ca suportul sa fie fixat la intervale regulate (cel puțin o data la 3 luni)
- Va rugam sa contactati furnizorul in cazul in care aveti intrebari.

*Specificatiile sunt supuse schimbarilor fara notificare prealabila.*

### Romania



#### **Reciclarea corecta a acestui produs (reziduuri provenind din aparatura electrica si electronica)**

Marcajale de pe acest produs sau mentionate in instructiunile sale de folosire indica faptul ca produsul nu trebuie aruncat impreuna cu alte reziduuri din gospodarie atunci cand nu mai este in stare de functionare. Pentru a preveni posibile efecte daunatoare asupra mediului inconjurator sau a sanatatii oamenilor datorate evacuarii necontrolate a reziduurilor, va rugam sa separati acest produs de alte tipuri de reziduuri si sa-l reciclati in mod responsabil pentru a promova refolosirea resurselor materiale.

Utilizatorii casnici sunt rugati sa ia legatura fie cu distribuitorul de la care au achizitionat acest produs, fie cu autoritatile locale, pentru a primi informatii cu privire la locul si modul in care pot depozita acest produs in vederea reciclarii sale ecologice.

Utilizatori institutionali sunt rugati sa ia legatura cu furnizorul si sa verifice conditiile stipulate in contractul de vanzare. Acest produs nu trebuie amestecat cu alte reziduuri de natura comerciala.



Produs in RPC pentru Lechpol Electronic SRL, Republicii nr. 5, Resita, CS , ROMANIA.



# UCH0112 LCD TV Wandhalterung

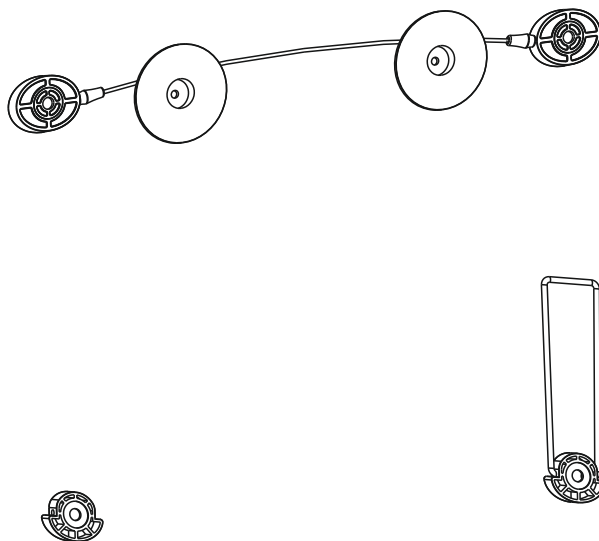

## Bedienungsanleitung



200x200/300x300  
400x200/400x400



55"  
MAX



50kg  
(110lbs)  
MAX

English 1-8

Polski 9-16

Română 17-24

Deutsch 25-32

## Vor Der Montage



- Beginnen Sie mit der Montage erst nachdem Sie die Montageanweisungen gelesen und verstanden haben.
- Befolgen Sie die Empfehlungen des Handbuchs bezüglich des benötigten Abstandes zwischen Wand und Halterung.
- Es wird empfohlen, die Montage von qualifiziertem Personal durchzuführen.
- Prüfen Sie, ob die Wand die Belastung der Halterung aushält.
- Überschreiten Sie nicht die maximal zulässige Last der Halterung.
- Bei einer Montage auf einer Holzwand achten Sie darauf, dass die Befestigungsschrauben in der Mitte der Pfosten zentriert werden (eventuell benutzen Sie eine Zentriervorrichtung).
- Ziehen Sie die Schrauben fest an, aber ziehen Sie die Schrauben nicht übermäßig an. Zu festes Anziehen der Schrauben, kann diese beschädigen und vermindert dadurch ihre Haltkraft.
- Bitten Sie eine andere Person um Hilfe für die Positionierung des Gerätes in der Halterung.
- Die Halterung ist nur für den Innenraum bestimmt. Verwenden Sie die Halterung nicht im Außenbereich um das Risiko von Verletzungen oder Beschädigungen am Produkt zu vermeiden.

## Inhalt Der Packung

Vor der Montage Stellen Sie sicher, dass alle notwendigen Einzelteile vorhanden sind anhand folgender Abbildungen.



Basisplatte (x2)  
A



Halterung (x1)  
B



supporting spacer (x1)  
C

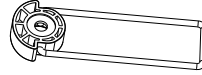

supporting spacer (x1)  
D

### Paket M



M5x14 (x4)  
M-A

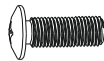

M6x14 (x4)  
M-B

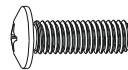

M8x20 (x4)  
M-C



M6x30 (x4)  
M-D



M8x30 (x4)  
M-E



D5 Scheibe(x4)  
M-F



D8 Scheibe(x4)  
M-G



Kleines Distanzstück  
(x8) M-H



Grosses Distanzstück  
(x4) M-I

### Paket W



Holzschraube ST5.5x50 (x2)  
W-A

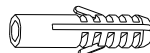

Betondübel (x2)  
W-B



D6 Scheibe (x2)  
W-C

## 1. Montage Auf Vollziegel oder Betonwand

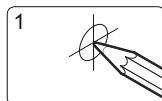
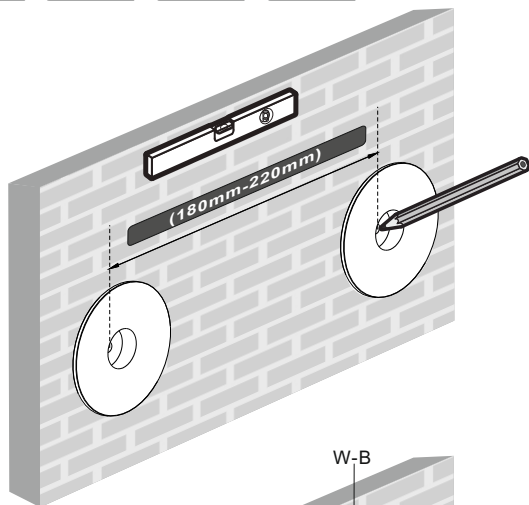
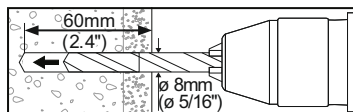
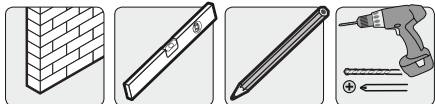

1  
Finden und markieren  
Sie die exakte Position  
der Montagelöcher

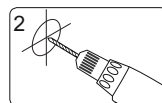

2  
Löcher vorbohren

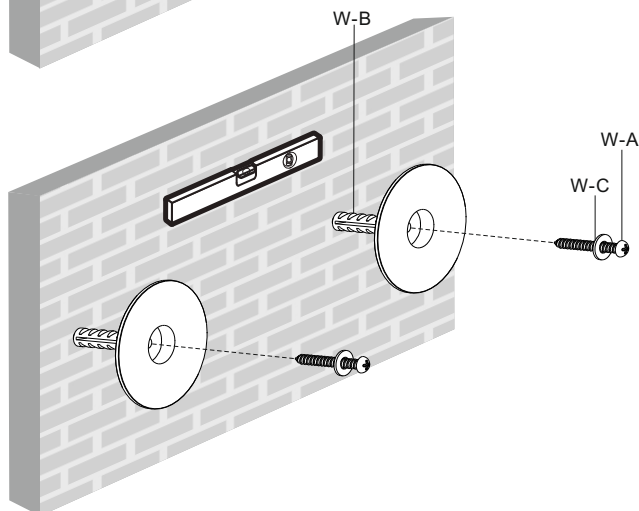
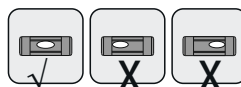

### **WARNUNG**

- Monteur müssen die Tragfähigkeit der Montagefläche überprüfen, ob diese die gesamte Last der Geräte und angeschlossenes Zubehör sicher aushält.

## 2. Montage der Adapterklammern

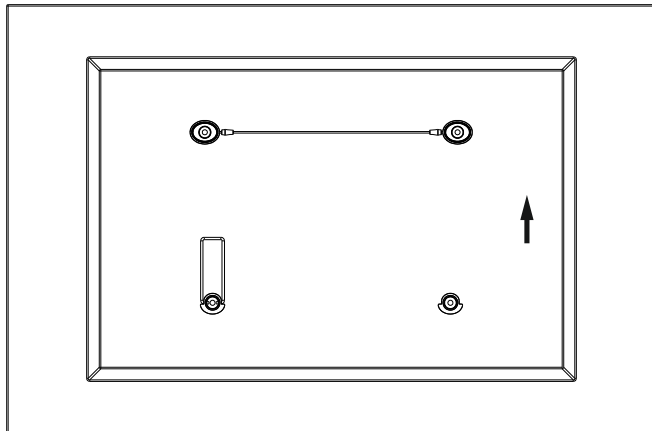

### 2-1 Für Fläche Hinterseite

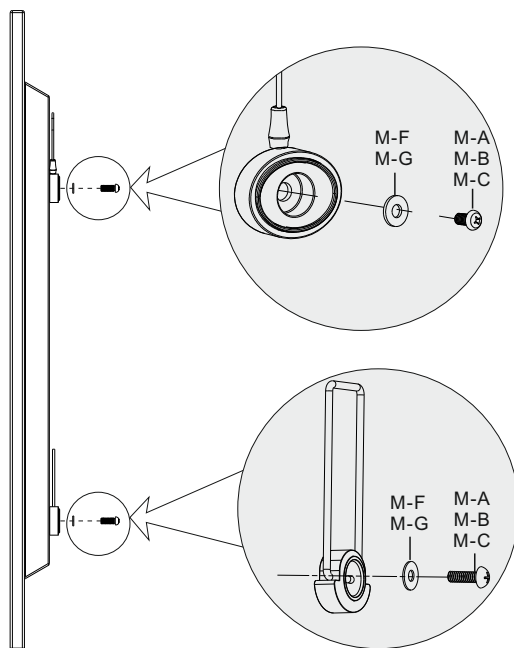
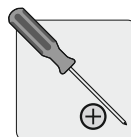
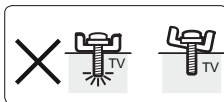
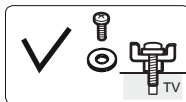

2-2 Für Zurückgesetzte Hinterseite oder Zugängliche A/V Eingänge

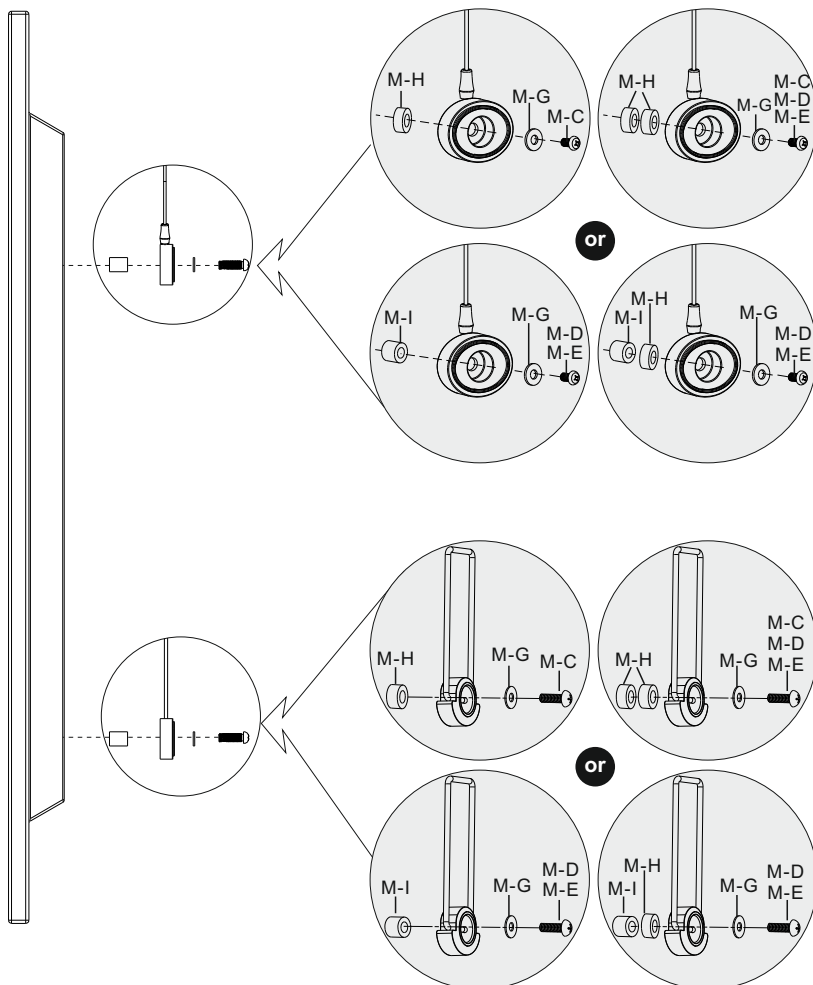
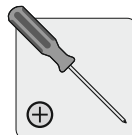

**Hinweis:** Wählen Sie passende Schrauben, Scheiben und Distanzstücke, (wenn nötig) passend zum Bildschirmtyp.

- Befestigen Sie die Adapterklammern mit Schrauben am Bildschirm.



**Alle Schrauben fest anziehen, aber nicht überdrehen.**

### 3. Aufhängen des TV auf die Wandplatte

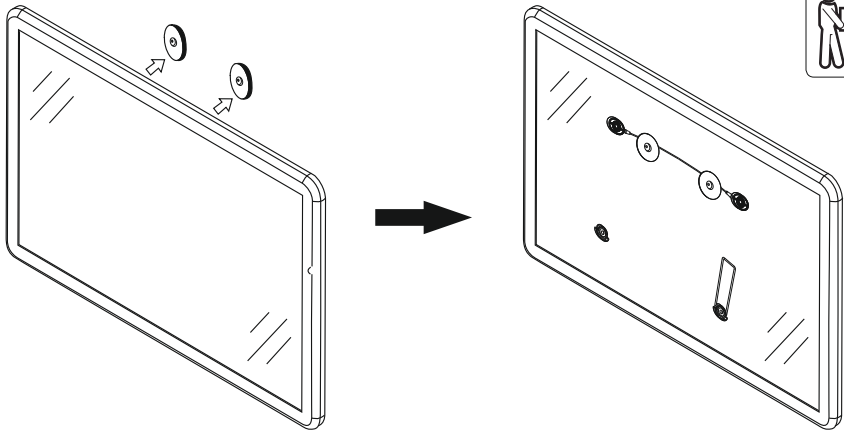

Nachdem die Wandhalterung sicher an der Wand befestigt wurde, heben Sie sorgfältig Ihren TV und haken das Drahtseil in die Wandplatten-Schiene. Stellen Sie sicher, dass Ihr Fernseher sicher und korrekt befestigt ist.

### 4. Kabelführung

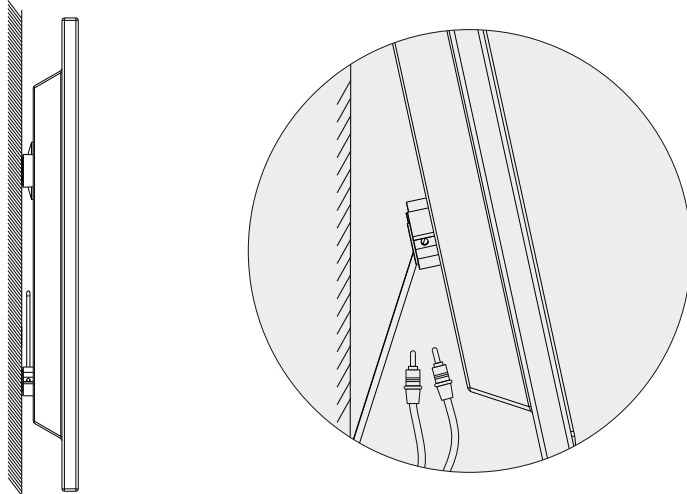

- Klappen Sie die Neigungsstütze aus, um auf die Kabel zuzugreifen.
- Neigungsstütze wieder zurückklappen nachdem alle Kabel angeschlossen wurden.

## Wartung

### Wartung

- Überprüfen Sie ob die Klammern sicher befestigt sind in regelmäßigen Abständen (zumindest alle drei Monate)
- Für etwaige Fragen wenden Sie sich an Ihren Händler.

Die Spezifikationen können ohne Ankündigung geändert werden.

### Deutsch



### Korrekte Entsorgung dieses Produkts (Elektromüll)

*(Anzuwenden in den Ländern der Europäischen Union und anderen europäischen Ländern mit einem separaten Sammelsystem)*

Die Kennzeichnung auf dem Produkt bzw. auf der dazugehörigen Literatur gibt an, dass es nach seiner Lebensdauer nicht zusammen mit dem normalen Haushaltsmüll entsorgt werden darf. Entsorgen Sie dieses Gerät bitte getrennt von anderen Abfällen, um der Umwelt bzw. der menschlichen Gesundheit nicht durch unkontrollierte Müllbeseitigung zu schaden. Recyceln Sie das Gerät, um die nachhaltige Wiederverwertung von stofflichen Ressourcen zu fördern

Private Nutzer sollten den Händler, bei dem das Produkt gekauft wurde, oder die zuständigen Behörden kontaktieren, um in Erfahrung zu bringen, wie sie das Gerät auf umweltfreundliche Weise recyceln können

Gewerbliche Nutzer sollten sich an Ihren Lieferanten wenden und die Bedingungen des Verkaufsvertrags konsultieren. Dieses Produkt darf nicht zusammen mit anderem Gewerbemüll entsorgt werden



Made in China für Lechpol Electronics Bv Provincialeweg 7, 3248 Lk Melissant, Holland











*[www.cabletech.pl](http://www.cabletech.pl)*