

Table of Contents

Title	Page
Overview	3
Unpacking Inspection	4
Safety Information	5
Rules For Safe Operation	6
International Electrical Symbols	9
The Meter Structure	10
Functional Buttons	11
Display Symbols	14
Measurement Operation	17
A. AC Current Measurement	17
B. DC Voltage Measurement	19
C. AC Voltage Measurement	20
D. Measuring Resistance	21
E. Testing for Diodes and Continuity	23
F. Frequency and Duty Cycle (%) Measurement (Duty Cycle: UT205A only)	25
G. Temperature Measurement (Model UT206A only)	27

Title	Page
Operation of Hold Mode	28
The Use of Relative Value Mode(Model UT206A only)	29
The SELECT Button	30
Turning on the Display Backlight	30
Sleep Mode	30
General Specifications	31
Accuracy Specifications	33
A. AC Current	33
B. DC Voltage	33
C. AC Voltage	34
D. Resistance	34
E. Diode and Continuity Test	35
F. Frequency	36
G. Duty Cycle (Model UT205A only)	36
H. Temperature (Model UT206A only)	36
Maintenance	37
A. General Service	37
B. Replacing the Battery	38

Overview

This Operating Manual covers information on safety and cautions. Please read the relevant information carefully and observe all the **Warnings** and **Notes** strictly.

Warning

To avoid electric shock or personal injury, read the “Safety Information” and “Rules for Safety Operation” carefully before using the Meter.

The **Model UT205A** and **UT206A** (hereafter referred to as “the Meter”) are a low consumption AC clamp meter with stabilize functions, safety operations, and reliable performance.

In addition to the AC current feature, it can also measure AC/DC voltages, resistance, diode, continuity, frequency and temperature.

Except where noted, the descriptions and instructions in this Operating Manual apply to both the **Model UT205A/UT206A**.

Unpacking Inspection

Open the package case and take out the Meter. Check the following items carefully to see any missing or damaged part:

Item	Description	Qty
1	Operating Manual	1 piece
2	Test Lead	1 pair
3	Model UT206A: Point Contact Temperature Probe	1 piece
4	9V Battery (NEDA 1604, 6F22 or 0006P) (installed inside the Meter)	1 piece
5	Vinyl Bag	1 piece

In the event you find any missing or damage, please contact your dealer immediately.

Safety Information

This Meter complies with the standards IEC61010: in pollution degree 2, overvoltage category (CAT. II 600V / CAT III 300V) and double insulation.

CAT II: Local level, appliance, PORTABLE EQUIPMENT etc., with smaller transient voltage overvoltages than CAT. III

CAT. III: Distribution level, fixed installation, with smaller transient overvoltages than CAT. IV.

Under the influence of Radiated, Radio-Frequency Electromagnetic Field phenomenon, the captioned model may malfunction and can self-recover after the test.

Use the Meter only as specified in this operating manual, otherwise the protection provided by the Meter may be impaired.

In this manual, a **Warning** identifies conditions and actions that pose hazards to the user, or may damage the Meter or the equipment under test.

A **Note** identifies the information that user should pay attention on. International electrical symbols used on the Meter and in this Operating Manual are explained on page 9.

Rules For Safe Operation

Warning

To avoid possible electric shock or personal injury, and to avoid possible damage to the Meter or to the equipment under test, adhere to the following rules:

- Check for the lever is in good condition when measuring AC current.
- Must center the wire (conductor) within the transformer jaw.
- Before using the Meter inspect the case. Do not use the Meter if it is damaged or the case (or part of the case) is removed. Look for cracks or missing plastic. Pay attention to the insulation around the connectors.
- Inspect the test leads for damaged insulation or exposed metal. Check the test leads for continuity. Replace damaged test leads with identical model number or electrical specifications before using the Meter.
- Do not apply more than the rated voltage, as marked on the Meter, between the terminals or between any terminal and grounding.
- The rotary switch should be placed in the right position and no any changeover of range shall be made during measurement is conducted to prevent damage of the Meter.
- When the Meter working at an effective voltage over 60V in DC or 42V rms in AC, special care should be taken for there is danger of electric shock.

- Use the proper terminals, function, and range for your measurements.
- When using the test leads, keep your fingers behind the finger guards.
- Disconnect circuit power and discharge all high-voltage capacitors before testing
- To avoid harms to you or damages to the Meter from electric shock, please do not attempt to apply higher than 600V between the terminals and grounding.
- Replace the battery as soon as the battery indicator  appears. With a low battery, the Meter might produce false readings that can lead to electric shock and personal injury.
- When servicing the Meter, use only the same model number or identical electrical specifications replacement parts.
- The internal circuit of the Meter shall not be altered at will to avoid damage of the Meter and any accident.
- Soft cloth and mild detergent should be used to clean the surface of the Meter when servicing. No abrasive and solvent should be used to prevent the surface of the Meter from corrosion, damage and accident.
- Turn the Meter off when it is not in use and take out the battery when not using for a long time.
- Constantly check the battery as it may leak when it has been using for some time, replace the battery as soon as leaking appears. A leaking battery will damage the Meter.

- Do not use or store the Meter in an environment of high temperature, humidity, explosive, inflammable and strong magnetic field. The performance of the Meter may deteriorate after dampened

International Electrical Symbols

~	AC (Alternating Current)
⋮	DC (Direct Current)
R	AC or DC
⊥	Grounding
□	Double Insulated
⊞	Fuse
⊞	Deficiency of Built-In Battery
•))	Continuity Test
-+	Diode
CE	Conforms to Standards of European Union
⚠	Warning. Refer to the Operating Manual
⚡	High Voltage Terminal

The Meter Structure (see figure 1)

1. Transformer Jaws designed to pick up the AC current flowing through the conductor.
2. Rotary Switch.
3. LCD Display.
4. Function Buttons
5. Input Terminals
6. Trigger. Press the lever to open the transformer jaws. When the pressure on the lever is released, the jaws will close.

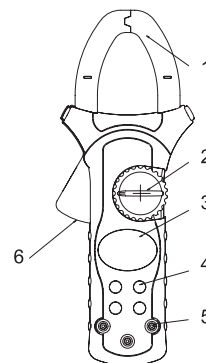

(figure 1)

Functional Buttons

Below table indicated for information about the functional button operations.

Button	Operation Performed
	Turn the display backlight on and off. In order to avoid the hazard arising from mistaken readings in insufficient light or poor vision, please use Display Backlight function.
Hz% (UT205A only)	<ol style="list-style-type: none"> At ACV or DCV range <ul style="list-style-type: none"> Press the button to step through ACV or DCV, frequency and duty cycle measurement. The Meters enters the manual ranging measurement mode after pressing the button at the ACV or DCV measurement range. Turn the rotary switch or switch off the Meter to return to auto ranging measurement mode.



Button	Operation Performed
Hz% (UT205A only)	<ul style="list-style-type: none"> The Meter is at the DCV – 400mV range or ACV –4V range after returning from the Hz% cycle measurement mode. <ol style="list-style-type: none"> At Hz range <ul style="list-style-type: none"> Press the button to step through frequency and duty cycle measurement mode.
RELΔ (UT206A only)	Press RELΔ to enter and exit the REL mode in any measuring mode except in frequency and duty cycle, the Meter beeps.
SELECT	<ul style="list-style-type: none"> UT206A: Switches between AC voltage and DC Voltage measurement, and continuity and diode measurement; the Meter beeps. UT205A: Switches between continuity and diode measurement; the Meter beeps.

Button	Operation Performed
SELECT	<ul style="list-style-type: none"> When it is under sleep mode, press to activate the Meter at the effective measurement range, e.g. continuity buzzer. Auto power off feature will be disabled until switch off and turn on the Meter again.
HOLD	Press HOLD to enter and exit the Hold mode in any mode, the Meter beeps.

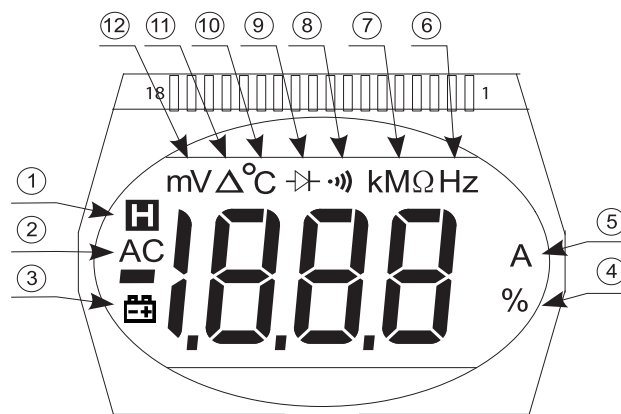
Display Symbols (see figure 2)





(figure 2)

Number	Symbol	Meaning
1		Data hold is active.
2	AC	Indicator for AC Voltage.
3		The battery is low. ⚠ Warning: To avoid false readings, which could lead to possible electric shock or personal injury, replace the battery as soon as the battery indicator appears.
4	%	Percent: Used for duty cycle measurements.
5	A	Indicator for AC current
6	Hz, kHz, MHz	Hertz. The unit of frequency. Kilohertz. 1×10^3 or 1000 hertz. Megahertz. 1×10^6 or 1,000,000 hertz.
7	Ω , k Ω , M Ω	Ohm. The unit of resistance. kilohm. 1×10^3 or 1000 ohms. Megaohm. 1×10^6 or 1,000,000 ohms.

Number	Symbol	Meaning
8		The continuity buzzer is on.
9	-+	Test of diode
10	°C	Centigrade. The unit of temperature.
11	Δ	The relative value mode is on to display the stored value minus the present
12	V, mV	Volts. The unit of voltage. Millivolt. 1×10^{-3} or 0.001 volts.

Measurement Operation

- Make sure the Sleep Mode is not on if you found there is no display on the LCD after turning on the Meter.
- Make sure the Low Battery Display  is not on; otherwise false readings may be provided.
- Pay extra attention to the  symbol which is located besides the input terminals of the Meter before carrying out measurement.
- Make sure you are in the proper measurement range before carrying out measurement.

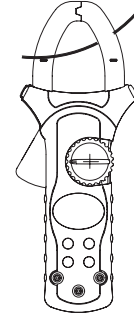

(figure 3)

A. AC Current Measurement (See figure 3)

Warning

The measurement value obtained is wrong if testing two or more current conductors at the same time.

To measure current, do the following:

1. Set the rotary switch to the current measurement mode.
2. Check the lever is in good condition.
3. Press the lever to open the transformer jaws.
4. Center the conductor within the transformer jaw.

The measured value shows on the display, it is a effective value of sine wave (mean value response).

Note

- When current measurement has been completed, disconnect the connection between the conductor under test and the jaw, and remove the conductor away from the transformer jaw of the Meter.

B. DC Voltage Measurement (See figure 4)**⚠ Warning**

To avoid harms to you or damages to the Meter from electric shock, please do not attempt to measure voltages higher than 600V although readings may be obtained.

To measure DC voltage, connect the Meter as follows:

1. Insert the red test lead into the **V** terminal and the black test lead into the **COM** terminal.
2. Set the rotary switch to DC voltage measurement mode.
3. Connect the test leads across with the object being measured.

The measured value shows on the display.

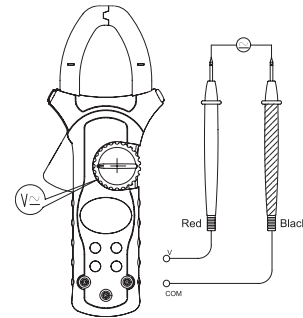

(figure 4)

Note

- In each range, the Meter has an input impedance of 10MΩ. This loading effect can cause measurement errors in high impedance circuits. If the circuit impedance is less than or equal to 10kΩ, the error is negligible (0.1% or less).
- When DC voltage measurement has been completed, disconnect the connection between the testing leads and the circuit under test, and remove the testing leads away from the input terminals of the Meter.

C. AC Voltage Measurement (See figure 4)

AC Voltage measurement is an auto ranging measurement mode.

Note:

- Follow the same procedure as the DC Voltage Measurement mode. When you using UT206A to carry out the measurement, use **SELECT** button to switch between ACV and DCV.

D. Measuring Resistance (see figure 5)**⚠ Warning**

To avoid damages to the Meter or to the devices under test, disconnect circuit power and discharge all the high-voltage capacitors before measuring resistance.

To measure resistance, connect the Meter as follows:

1. Insert the red test lead into the Ω terminal and the black test lead into the **COM** terminal.
2. Set the rotary switch to Ω .
3. Connect the test leads across with the object being measured.

The measured value shows on the display.

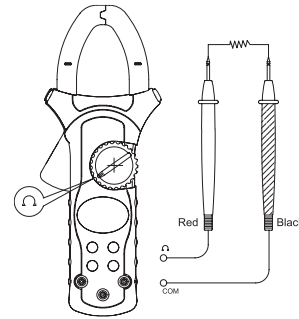

(figure 5)

Note

- The test leads can add 0.1Ω to 0.3Ω of error to resistance measurement.

- To obtain precision readings in low-resistance measurement, that is the range of 400.0Ω , short-circuit the input terminals beforehand, using the relative measurement function button **REL** Δ to automatically subtract the value measured when the testing leads are short-circuited from the reading.
- For high-resistance measurement ($>1M\Omega$), it is normal to take several seconds to obtain a stable reading.
- When resistance measurement has been completed, disconnect the connection between the testing leads and the circuit under test, and remove the testing leads away from the input terminals of the Meter.

E. Testing for Diodes and Continuity (See figure 6)

Warning

To avoid damages to the Meter or to the devices under test, disconnect circuit power and discharge all the high-voltage capacitors before testing for continuity.

To test for diodes and continuity, connect the Meter as below:

1. Insert the red test lead into the $- + \text{⏏}$ terminal and the black test lead into the **COM** terminal.
2. For diode test
 - a. Set the rotary switch to $- + \text{⏏}$.
 - b. For forward voltage drop readings on any semiconductor component, place the red test lead on the component's anode and place the black test lead on the component's cathode.

The measured value shows on the display.

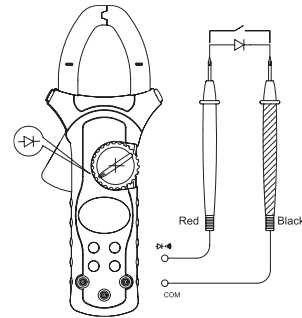

(figure 6)

3. For continuity test:
 - a. Press **SELECT** to switch between Diode and Continuity test.
 - b. Connect the test lead to the two end of the circuit under test.
 - c. The buzzer sounds if the resistance of a circuit under test is less than 100Ω .

Note

- In a circuit, a good diode should still produce a forward voltage drop reading of 0.5V to 0.8V; however, the reverse-voltage drop reading can vary depending on the resistance of other pathways between the probe tips.
- Connect the test leads to the proper terminals as said above to avoid error display. The LCD will display **OL** indicating diode being tested is open or polarity is reversed. The unit of diode is Volt (V), displaying the forward voltage drop readings.
- When diode and continuity testing has been completed, disconnect the connection between the testing leads and the circuit under test, and remove the testing leads away from the input terminals of the Meter.

F. Frequency and Duty Cycle (%) Measurement (See figure 7)

UT205A has both frequency and duty cycle measurement feature
 UT206A has only frequency measurement feature

To measure frequency and duty cycle, connect the Meter as follows:

1. UT205A

- a. Insert the red test lead into the **Hz%** terminal and the black test lead into the **COM** terminal.
- b. Set the rotary switch to **Hz**; press **Hz%** button to switch between Hz and Duty cycle measurement mode.
- c. Or set the rotary to ACV or DCV range, then press **Hz%** button to switch between ACV or DCV, Hz and Duty cycle measurement mode. But the accuracy will have a little difference based on the input frequency and wave.

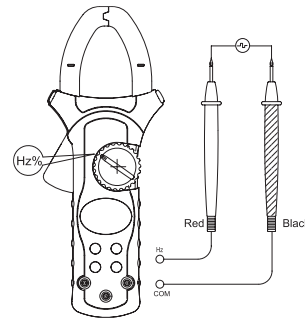

(figure 7)

- d. Connect the test leads across with the object being measured.
 The measured frequency value or duty cycle value shows on the display.

2. UT206A

- a. Insert the red test lead into the **Hz** terminal and the black test lead into the **COM** terminal.
- b. Set the rotary switch to Hz.
- c. Connect the test leads across with the object being measured.
 The measured frequency value shows on the display.

Note

- When frequency and duty cycle measurement has been completed, disconnect the connection between the testing leads and the circuit under test, and remove the testing leads away from the input terminals of the Meter.

G. Model UT206A: Temperature Measurement (See figure 8)

To measure temperature, connect the Meter as follows:

1. Insert the red temperature probe into the °C terminal and the black temperature probe into the **COM** terminal.
2. Set the rotary switch to °C.
3. Place the temperature probe to the object being measured.

The measured value shows on the display.

Note

- When there is no temperature probe inserted into the terminals, the LCD displays **OL**.
- The included point contact temperature probe can only be used up to 250 °C. For any measurement higher than that, it is necessary to use another type of temperature probe.
- When temperature measurement has been completed, disconnect the connection between the testing leads and the circuit under test, and remove the testing leads away from the input terminals of the Meter.

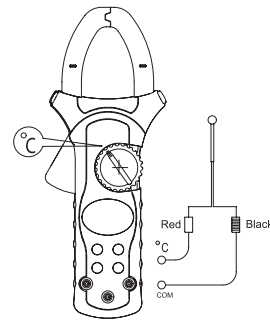

(figure 8)

Operation of Hold Mode

 **Warning**

To avoid possibility of electric shock, do not use Hold mode to determine if circuits are without power. The Hold mode will not capture unstable or noisy readings.

The Hold mode is applicable to all measurement functions.

- Press **HOLD** to enter Hold mode; the Meter beeps.
- Press **HOLD** again or turn the rotary switch to exit Hold mode; the Meter beeps.
- In Hold mode,  is displayed.

The Use of Relative Value Mode (UT206A only)

The REL Δ mode applies to all measurement functions except frequency and duty cycle. It subtracts a stored value from the present measurement value and displays the result.

For instance, if the stored value is 20.0V and the present measurement value is 22.0V, the reading would be 2.0V. If a new measurement value is equal to the stored value then display 0.0V.

To enter or exit REL Δ mode:

- Use rotary switch to select the measurement function before selecting REL Δ . If measurement function changes manually after REL Δ is selected, the Meter exits the REL Δ mode.
- Press REL Δ to enter REL Δ mode, auto ranging turns off, and the present measurement range is locked and stored as the stored value. All the measurements done after will be automatically subtract this stored value.
- Press REL Δ again to exit REL Δ mode and return to common measurement mode. If you want to enter the auto ranging measurement mode or other ranges, please turn the rotary switch or power off the Meter and start again.

The SELECT Button



It uses for selecting the required measurement function when there is more than one function at one position of the rotary switch.

Turning on the Display Backlight



Warning

In order to avoid the hazard arising from mistaken readings in insufficient light or poor vision, please use Display Backlight function.

- Press and hold  button for over 2 seconds to turn the Display Backlight on.
- Press  button again to turn the Display Backlight off, otherwise it will stay on continuously.



Sleep Mode

To preserve battery life, the Meter automatically turns off if you do not turn the rotary switch or press any button for around 15 minutes.

The Meter can be activated by turning the rotary switch or pressing the effective button, it will return to working mode.

General Specifications

- Maximum Voltage between any Terminals and Grounding: 600V rms or 600V DC.
- Maximum Current Measurement of Transformer Jaw: 1000A.
- Maximum Jaw Size: 40mm.
- Maximum Display: Digital: 3999, 3 3/4 digits
- Overload Display: OL
- Range: Auto
- Polarity Display: Negative display: “-“
- Measurement Speed: Updates 3 times/second.
- Temperature: Operating: 0°C to +40°C (32°F to +104°F).
Storage: -10°C to +50°C (14°F to +122°F).
- Relative Humidity: ≤75% @ 0°C to 40°C; ≤70% @ -10 to 50°C.
- Altitude: Operating: 2000 m.
Storage: 10000 m.

- Battery Type: One piece of 9V (NEDA1604 or 6F22 or 006P).
- Battery Deficiency: Display 
- Dimensions (HxWxL): 236mm x 97mm x 40mm
- Weight: Approximate 350g (battery included).
- Safety/Compliances: IEC61010 CAT. II 600V / CAT III 300V overvoltage and double insulation standard.
- Certifications: 
- Auto power off

Accuracy Specifications

Accuracy: \pm (a% reading + b digits), guarantee for 1 year.
 Operating temperature: 23°C \pm 5°C.
 Relative humidity: ≤75%.

A. AC Current

Range	Resolution	Accuracy	Remarks
400A	0.1A	$\pm(1.5\%+5)$	Frequency response 50Hz~60Hz. Display effective value of sine wave (mean value response).
1000A	1A	800A $\geq \pm(2\%+5)$ >800A $\pm(3\%+5)$	

B. DC Voltage

Range	Resolution	Accuracy	Overload Protection	Remarks
400mV	100 μ V	$\pm(0.8\%+3)$	600V DC 600V AC	Input impedance: around 10M Ω .
4V	1mV	$\pm(0.8\%+1)$		
40V	10mV			
400V	100mV			
600V	1V	$\pm(1\%+3)$		

C. AC Voltage



Range	Resolution	Accuracy	Overload Protection	Remarks
40V	1mV	$\pm(1.2\%+5)$	600V DC 600V AC	Input impedance around 10M Ω . Displays effective value of sine wave (mean value response). Frequency response: 40Hz ~ 400Hz.
40V	10mV			
400V	100mV			
600V	1V	$\pm(1.5\%+5)$		

D. Resistance

Range	Resolution	Accuracy	Overload Protection
400 Ω	0.1 Ω	$\pm(1.2\%+2)$	500V DC or AC
4k Ω	1 Ω	$\pm(1\%+2)$	

Range	Resolution	Accuracy	Overload Protection
40kΩ	10Ω	±(1%+2)	500V DC or AC
400kΩ	100Ω		
4MΩ	1kΩ	±(1.2%+2)	
40MΩ	10kΩ	±(1.5%+2)	

E. Diode and Continuity Test

Function	Range	Resolution	Overload	Remarks
Diode		1mV	500V DC or AC	Displays the nearest value of forward voltage drop
Continuity		0.1Ω		Buzzer beeps when ≤100Ω

F. Frequency (auto-ranging)

Range	Resolution	Accuracy	Overload Protection	Remarks
10Hz-10MHz	Min 0.001Hz	±(0.1%+3)	500V DC or VAC	Input Voltage: ≤1MHz: 300mV rms ≤ a ≤ 30V rms; >1MHz: 600mV rms ≤ a ≤ 5V rms

G. Duty Cycle (Model UT205A only)

Range	Resolution	Accuracy	Overload Protection
0.1%-99.9%	0.1%	For reference only	500V DC or AC

H. Temperature (Model UT206A only)

Range	Resolution	Accuracy	Overload Protection
-40°C~0°C	1°C	± (4%+4)	500V DC or AC
1°C~400°C		± (2%+8)	
401°C~1000°C		± (3%+10)	

Maintenance

This section provides basic maintenance information including battery replacement instruction.

Warning

Do not attempt to repair or service your Meter unless you are qualified to do so and have the relevant calibration, performance test, and service information.

To avoid electrical shock or damage to the Meter, do you get water inside the case.

A. General Service

- Periodically wipe the case with a damp cloth and mild detergent. Do not use abrasives or solvents.
- To clean the terminals with cotton bar with detergent, as dirt or moisture in the terminals can affect readings.
- Turn the Meter to **OFF** position when it is not in use.
- Take out the battery when it is not using for a long time.
- Do not use or store the Meter in a place of humidity, high temperature, explosive, inflammable and strong magnetic field.

B. Replacing the Battery (See figure 9)

Warning

To avoid false readings, which could lead to possible electric shock or personal injury, replace the battery as soon as the battery indicator “” appears.

Make sure the transformer jaw and the test leads are disconnected from the circuit being tested before opening the case bottom.

Make sure the test leads are removed from the input terminals.

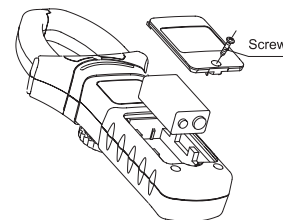

(figure 9)

To replace the battery:

1. Turn the rotary switch of the Meter to **OFF** position and remove all the connections from the terminals.
2. Remove the screw from the battery compartment, and separate the battery compartment from the case bottom.
3. Remove the battery from the battery compartment.
4. Replace the battery with a new 9V battery (NEDA1604, 6F22 or 006P) and or a 1.5V battery (AAA).
5. Rejoin the case bottom and battery compartment, and reinstall the screw.

**** END ****

©Copyright 2006 Uni-Trend Group Limited.
All rights reserved.

Manufacturer:
Uni-Trend Technology (Dongguan) Limited
Dong Fang Da Dao
Bei Shan Dong Fang Industrial Development District
Hu Men Town, Dongguan City
Guang Dong Province
China
Postal Code: 523 925

Headquarters:
Uni-Trend Group Limited
Rm901, 9/F, Nanyang Plaza
57 Hung To Road
Kwun Tong
Kowloon, Hong Kong
Tel: (852) 2950 9168
Fax: (852) 2950 9303
Email: info@uni-trend.com
<http://www.uni-trend.com>